

TP4T-712GP

70 SUPERLOTUS TOP
GAS SOLID TOP - TOP

Solid top + 4 burners - Plate 37x57 (included
1 Head end filler strip mod.TPA-7)



Construction - Fabricated using CrNi 18/10 AISI 304 grade Stainless Steel Scotch-Brite Satin polish Finish, incorporating 2 mm thick worktop, rounded edges, chromed details and rear splash back. Knobs with waterproof grades IPX5. **Model** - Professional Gas Solid Top, versions with or without 2 or 4 burners. Piezoelectric ignition with pilot light, 15mm thick steel top for the best in heat conductivity including thermocouple safety valves. Burners with ignition by pilot light, taps with thermocouple safety valve. Modulating flame burners, grills in stainless steel rods or cast iron, with removable liquid collectors. **Maintenance** - All serviceable parts are accessible by the easy removal of front control panel and removable collectors. **Fittings** - Appliance is supplied with both LPG and Natural Gas conversion jets and adjustable feet.

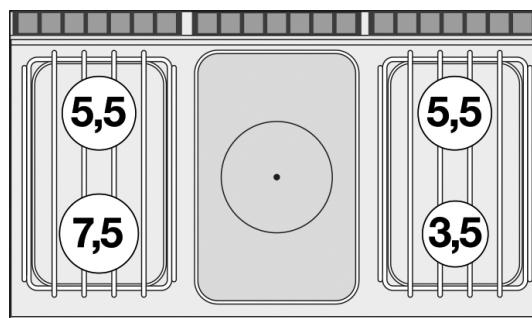

ITALIAN CULINARY ART

The pictures are purely representative. The manufacturer reserves the right to modify the technical data and models without previous notice.

TP4T-712GP

70 SUPERLOTUS TOP
GAS SOLID TOP - TOP

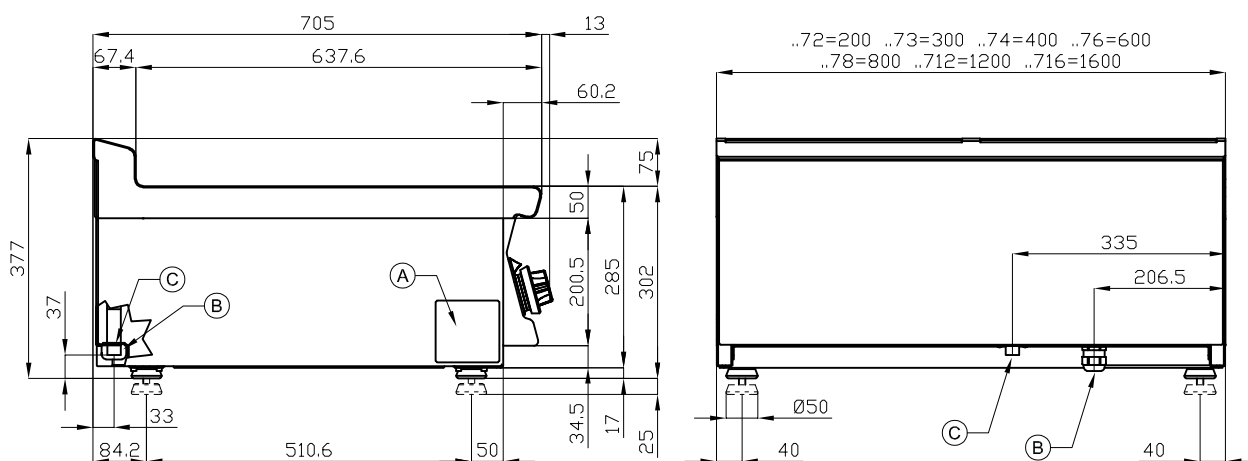

A	Data plate		C	Gas connection	ISO 7-1 3/4" M
---	------------	--	---	----------------	----------------

MODEL: TP4T-712GP
 DIMENSIONS: cm. 120x 70,5x 28h
 GAS POWER: 29 kW / 24.940 kcal/h
 GAS TYPE: Natural Gas / LPG

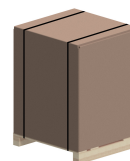

kg: 202
 m³: 0.511
 mm: 1230x770x540

BUY LOTUS BUY ITALY

The pictures are purely representative. The manufacturer reserves the right to modify the technical data and models without previous notice.



LOTUS S.P.A. Via Calmaor, 46
 31020 San Vendemiano(TV) - Italy
 Tel. + 39 0438 778020 / 778468
 Fax + 39 0438 778277
 www.lotuscookers.it - lotus@lotuscookers.it