

SB79T-5,6A

HIGHLLOTUS

CANTILEVER STRUCTURE 2 sides S70/S90 self-supporting

CANTILEVER STRUCTURE 2 sides S70T/90T, 2
self-supporting feet

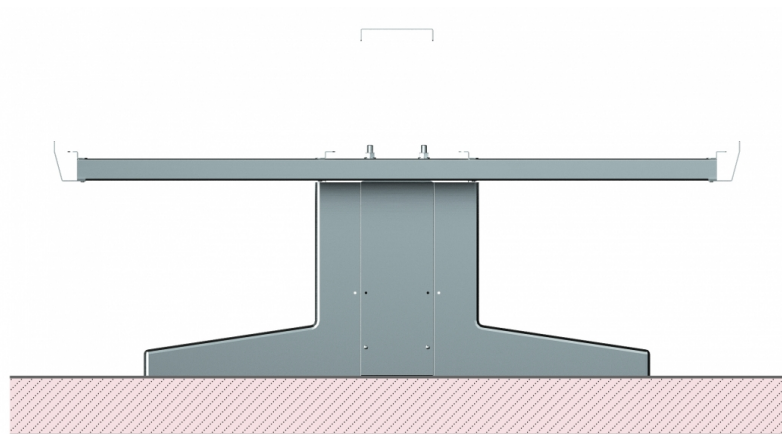

Construction - Basic structure made in galvanized iron 4mm thick.
Structure for support cooking appliances in stainless steel CrNi 18/10 304
with 3 mm thick. External panels with Stainless Steel Scotch-Brite Satin
polish Finish, rounded edges, chromed details. Model - Cantilever
structure for professional kitchens, designed for the support of the line
Superlotus 70 on one side and Iperlotus 90 on the other side.
Maintenance - All serviceable parts are accessible by the easy removal of
front external panels.



ITALIAN CULINARY ART

The pictures are purely representative. The manufacturer reserves the right to modify the technical data and models without previous notice.

SB79T-5,6A

HIGHLLOTUS

CANTILEVER STRUCTURE 2 sides S70/S90 self-supporting

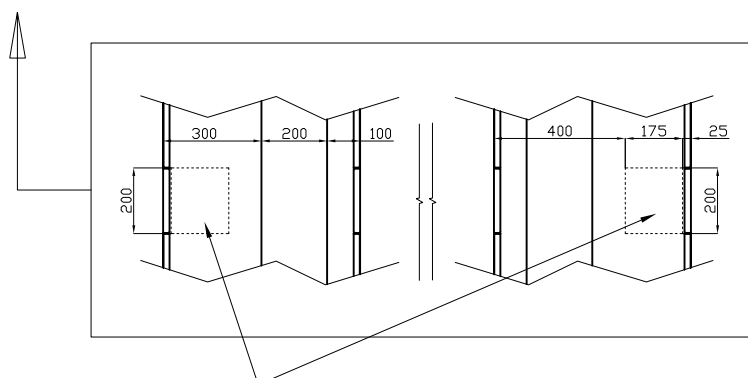
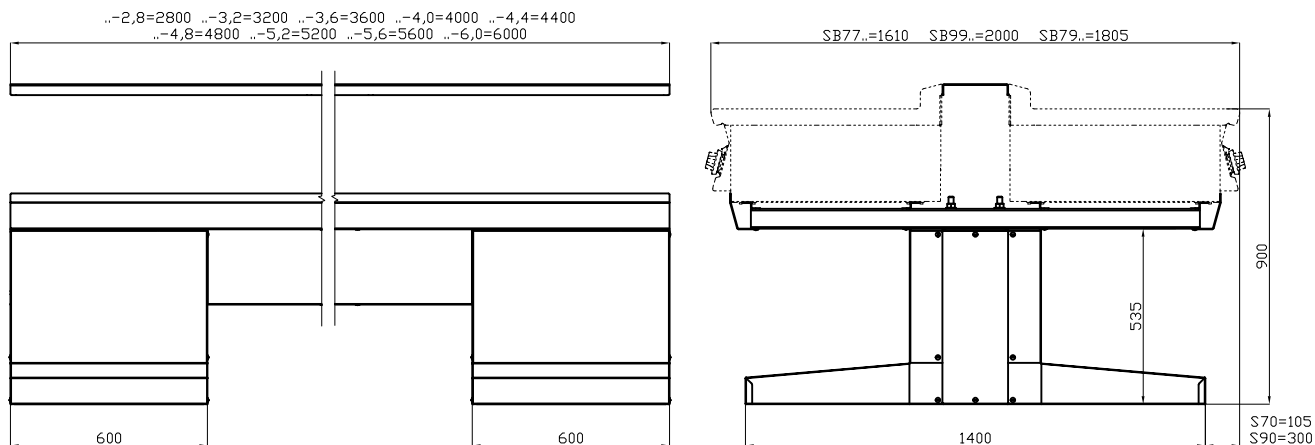

Passaggio per allacciamenti/ Durchgang für Verbindungen/ Passage pour les connexions
 Passage for connections/ Paso para las conexiones

A	Data plate				
---	------------	--	--	--	--

MODEL: SB79T-5,6A
 DIMENSIONS: cm. 560x180,5x 90h



kg: 410
 m³: 6.783
 mm: 5700x1700x700

BUY LOTUS BUY ITALY

The pictures are purely representative. The manufacturer reserves the right to modify the technical data and models without previous notice.



LOTUS S.P.A. Via Calmaor, 46
 31020 San Vendemiano(TV) - Italy
 Tel. + 39 0438 778020 / 778468
 Fax + 39 0438 778277
 www.lotuscookers.it - lotus@lotuscookers.it