

SB70T-2,4

HIGHLLOTUS

CANTILEVER STRUCTURE 1 side S70

CANTILEVER STRUCTURE 1 side S70T, 1 foot
for ground fixing

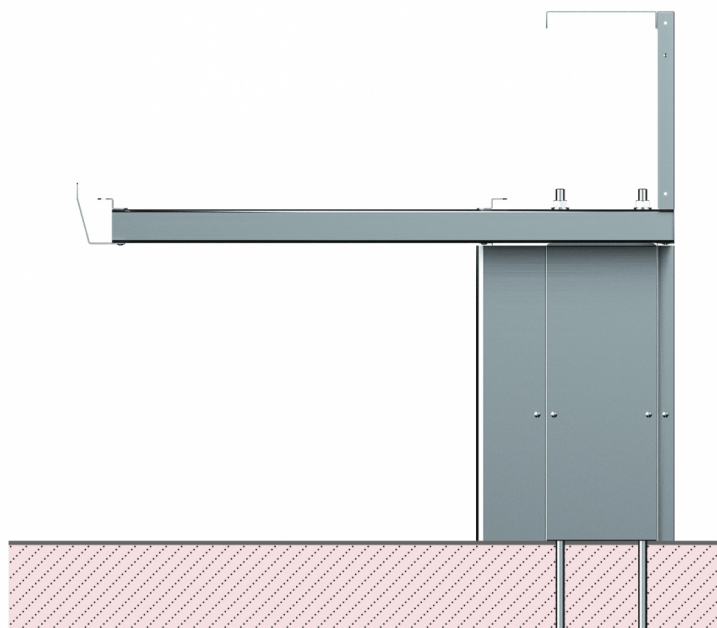

Construction - Basic structure made in galvanized iron 4mm thick.
Structure for support cooking appliances in stainless steel CrNi 18/10 304
with 3 mm thick. External panels with Stainless Steel Scotch-Brite Satin
polish Finish, rounded edges, chromed details. Model - Cantilever
structure for professional kitchens, designed for the support of the
Superlotus 70 line. Maintenance - All serviceable parts are accessible by
the easy removal of front external panels.



ITALIAN CULINARY ART

The pictures are purely representative. The manufacturer reserves the right to modify the technical data and models without previous notice.

SB70T-2,4

HIGHLLOTUS

CANTILEVER STRUCTURE 1 side S70

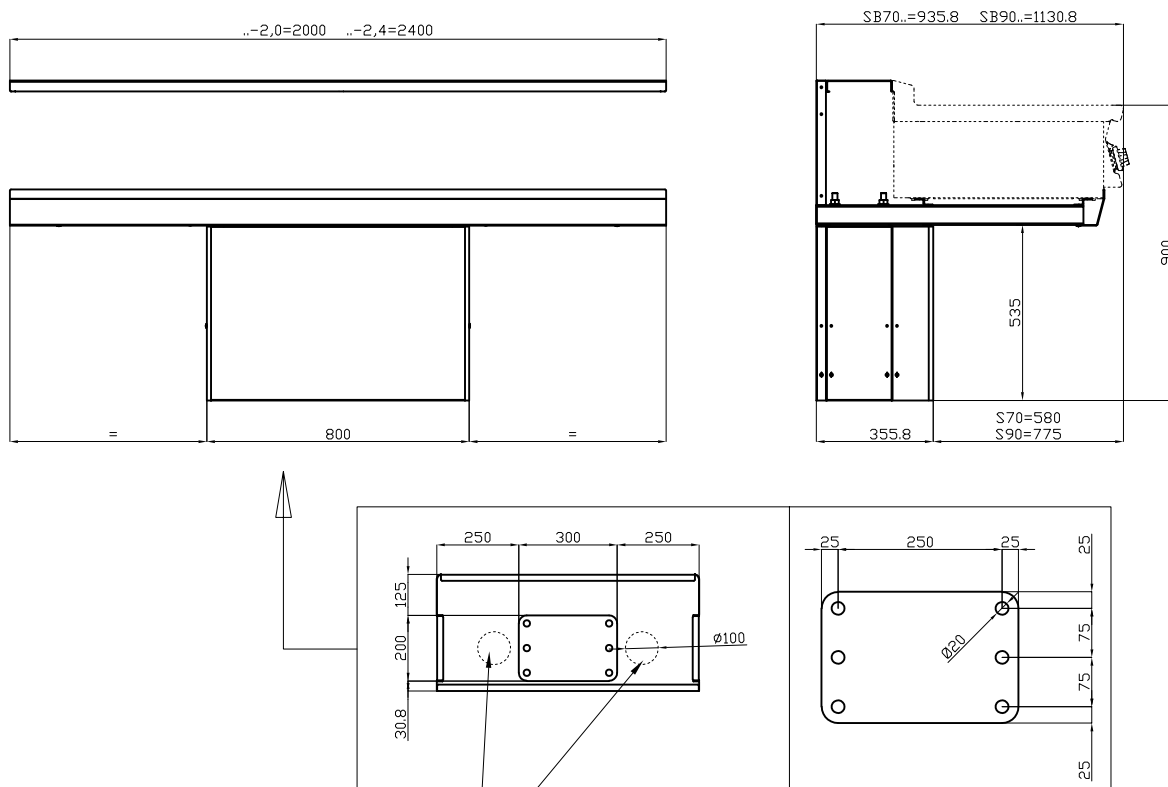

Passaggio per allacciamenti/ Durchgang für Verbindungen/ Passage pour les connexions
Passage for connections/ Paso para las conexiones

A	Data plate				
---	------------	--	--	--	--

MODEL:

SB70T-2,4

DIMENSIONS:

cm. 240x 93,6x 90h



kg: 120
m³: 1.575
mm: 2500x900x700

BUY LOTUS BUY ITALY

The pictures are purely representative. The manufacturer reserves the right to modify the technical data and models without previous notice.



LOTUS S.P.A. Via Calmaor, 46
31020 San Vendemiano(TV) - Italy
Tel. + 39 0438 778020 / 778468
Fax + 39 0438 778277
www.lotuscookers.it - lotus@lotuscookers.it