

PLST-76

70 SUPERLOTUS TOP WORK TOP - TOP

Worktop (included 1 Head end filler strip
mod.TPA-7)



Construction - Fabricated using CrNi 18/10 AISI 304 grade Stainless Steel Scotch-Brite Satin polish Finish, incorporating 2 mm thick worktop, rounded edges, chromed details and rear splash back. Model - Professional worktop with or without drawer . Fittings - Appliance is supplied with steel or plastic tanks, h 15cm. Adjustable feet.



ITALIAN CULINARY ART

The pictures are purely representative. The manufacturer reserves the right to modify the technical data and models without previous notice.

PLST-76

70 SUPERLOTUS TOP
WORK TOP - TOP

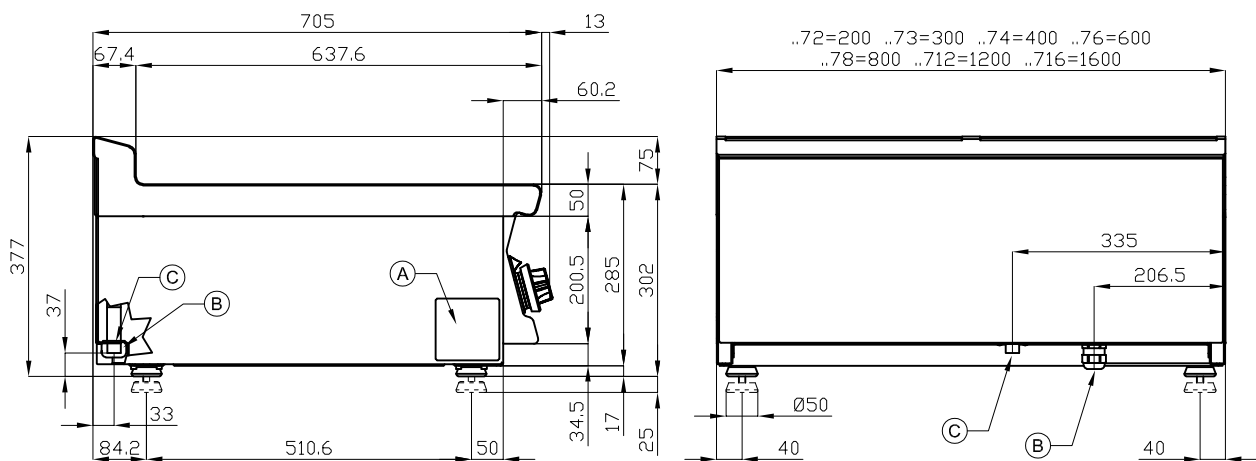

A	Data plate				
---	------------	--	--	--	--

MODEL: PLST-76
DIMENSIONS: cm. 60x 70,5x 28h



kg: 27
m³: 0.262
mm: 630x770x540

BUY LOTUS BUY ITALY

The pictures are purely representative. The manufacturer reserves the right to modify the technical data and models without previous notice.



LOTUS S.P.A. Via Calmaor, 46
31020 San Vendemiano(TV) - Italy
Tel. + 39 0438 778020 / 778468
Fax + 39 0438 778277
www.lotuscookers.it - lotus@lotuscookers.it