

PCT-78GP

70 SUPERLOTUS TOP GAS BOILING UNIT - TOP

Gas heated boiling unit - 4 burners (included
1 Head end filler strip mod.TPA-7)



Construction -Fabricated using CrNi 18/10 AISI 304 grade Stainless Steel Scotch-Brite Satin polish Finish, incorporating 2 mm thick worktop, rounded edges, chromed details and rear splash back. Knobs with waterproof grades IPX5. Model - Professional Gas Boiling Hob. Burners with pilot light ignition and thermocouple safety valves. Modulating flame burners, grills in stainless steel rods or in cast iron, removable liquid collectors. Maintenance - All serviceable parts are accessible by the easy removal of front control panel and liquid collectors. Fittings - Appliance is supplied with both LPG and Natural Gas conversion jets and adjustable feet.

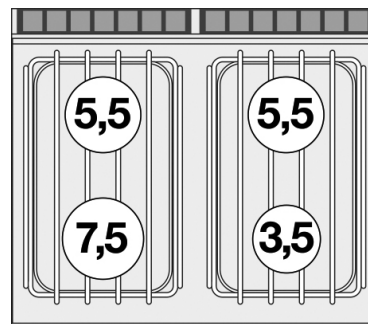

ITALIAN CULINARY ART

The pictures are purely representative. The manufacturer reserves the right to modify the technical data and models without previous notice.

PCT-78GP

70 SUPERLOTUS TOP GAS BOILING UNIT - TOP

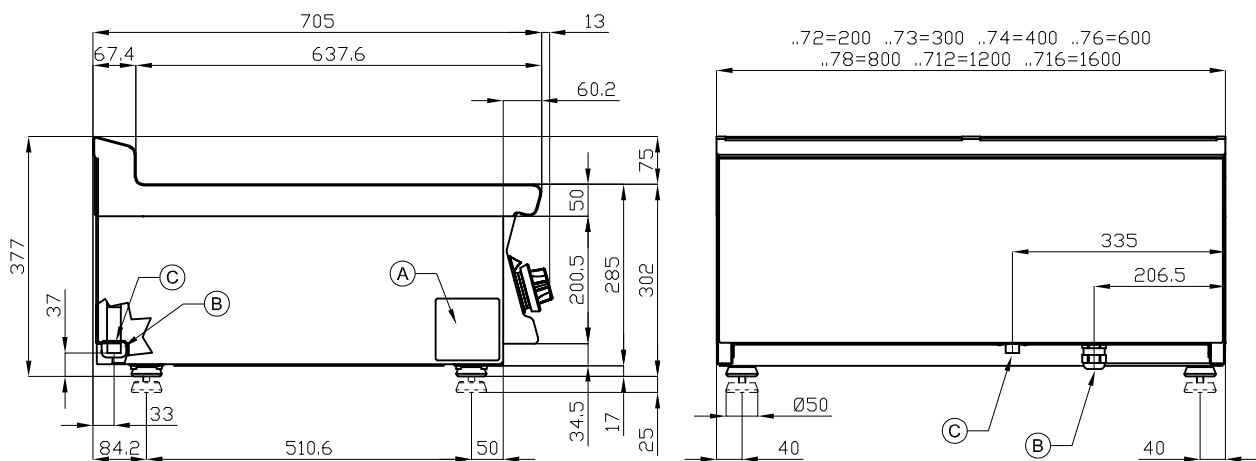

A	Data plate		C	Gas connection	ISO 7-1 1/2" M
---	------------	--	---	----------------	----------------

MODEL: PCT-78GP
DIMENSIONS: cm. 80x 70,5x 28h
GAS POWER: 22 kW / 18.920 kcal/h
GAS TYPE: Natural Gas / LPG



kg: 73
m³: 0.345
mm: 830x770x540

BUY LOTUS BUY ITALY

The pictures are purely representative. The manufacturer reserves the right to modify the technical data and models without previous notice.



LOTUS S.P.A. Via Calmaor, 46
 31020 San Vendemiano (TV) - Italy
 Tel. + 39 0438 778020 / 778468
 Fax + 39 0438 778277
 www.lotuscookers.it - lotus@lotuscookers.it