

MPS-20

65 MAGICPROF STAND

Stand with sliding doors

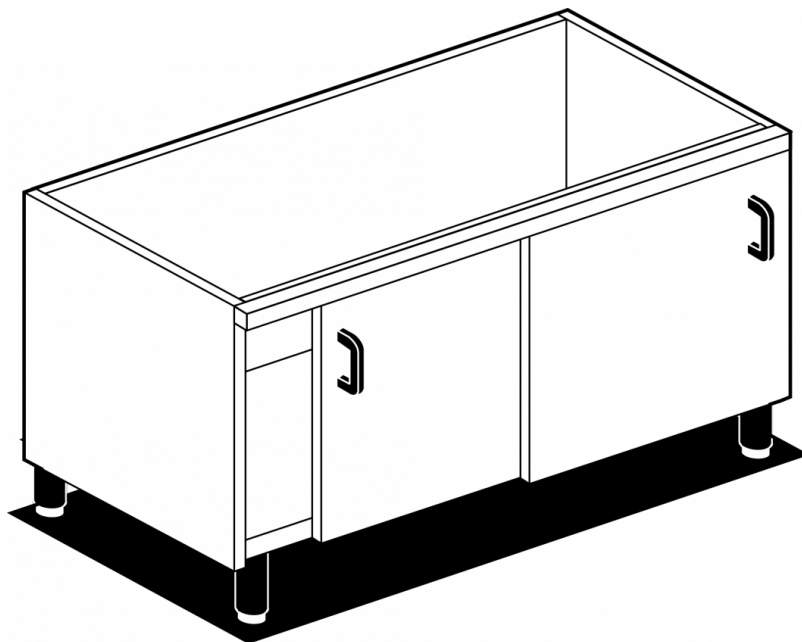

Construction - Fabricated using CrNi 18/10 AISI 304 grade Stainless Steel
Scotch-Brite Satin polish Finish, rounded edges. Model - Professional
Stand and Worktop Units. Fittings - Appliance is supplied with
adjustable feet.



ITALIAN CULINARY ART

The pictures are purely representative. The manufacturer reserves the right to modify the technical data and models without previous notice.

MPS-20

65 MAGICPROF
STAND

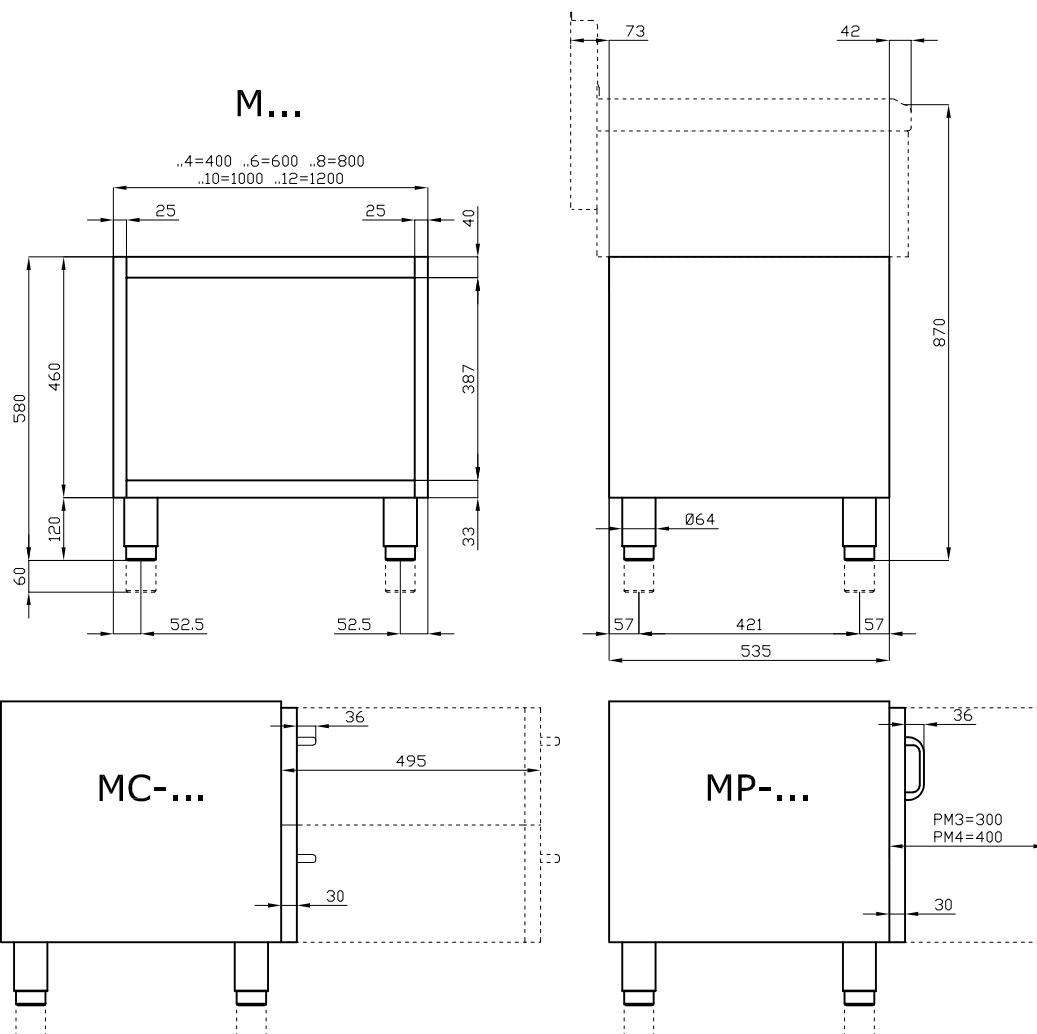

A	Data plate				
---	------------	--	--	--	--

MODEL: MPS-20
DIMENSIONS: cm. 200x 56,5x 58h



kg: 67
m³: 0.906
mm: 2080x670x650

BUY LOTUS BUY ITALY

The pictures are purely representative. The manufacturer reserves the right to modify the technical data and models without previous notice.



LOTUS S.P.A. Via Calmaor, 46
31020 San Vendemiano(TV) - Italy
Tel. + 39 0438 778020 / 778468
Fax + 39 0438 778277
www.lotuscookers.it - lotus@lotuscookers.it