

# M-712

## 70 SUPERLOTUS TOP STAND

Open Stand

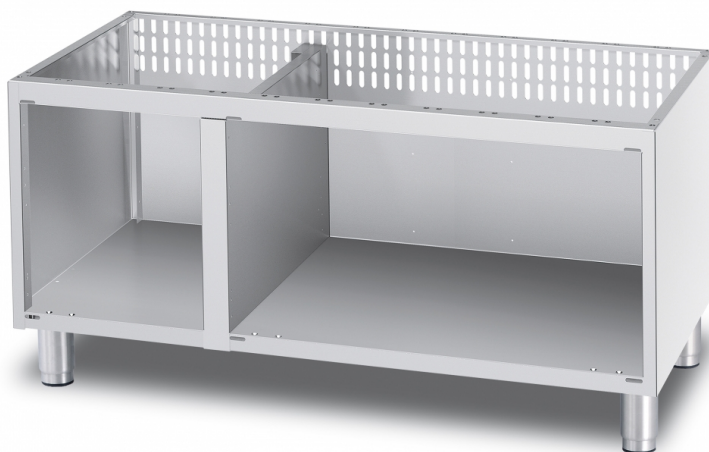

Construction - Fabricated using CrNi 18/10 AISI 304 grade Stainless Steel  
Scotch-Brite Satin polish Finish, rounded edges and chromed details.  
Model - Professional Stand for Induction and Worktop Units. Fittings -  
Appliance is supplied with adjustable feet, Doors not Included, except for  
Induction Unit top.



ITALIAN CULINARY ART

The pictures are purely representative. The manufacturer reserves the right to modify the technical data and models without previous notice.

# M-712

## 70 SUPERLOTUS TOP STAND

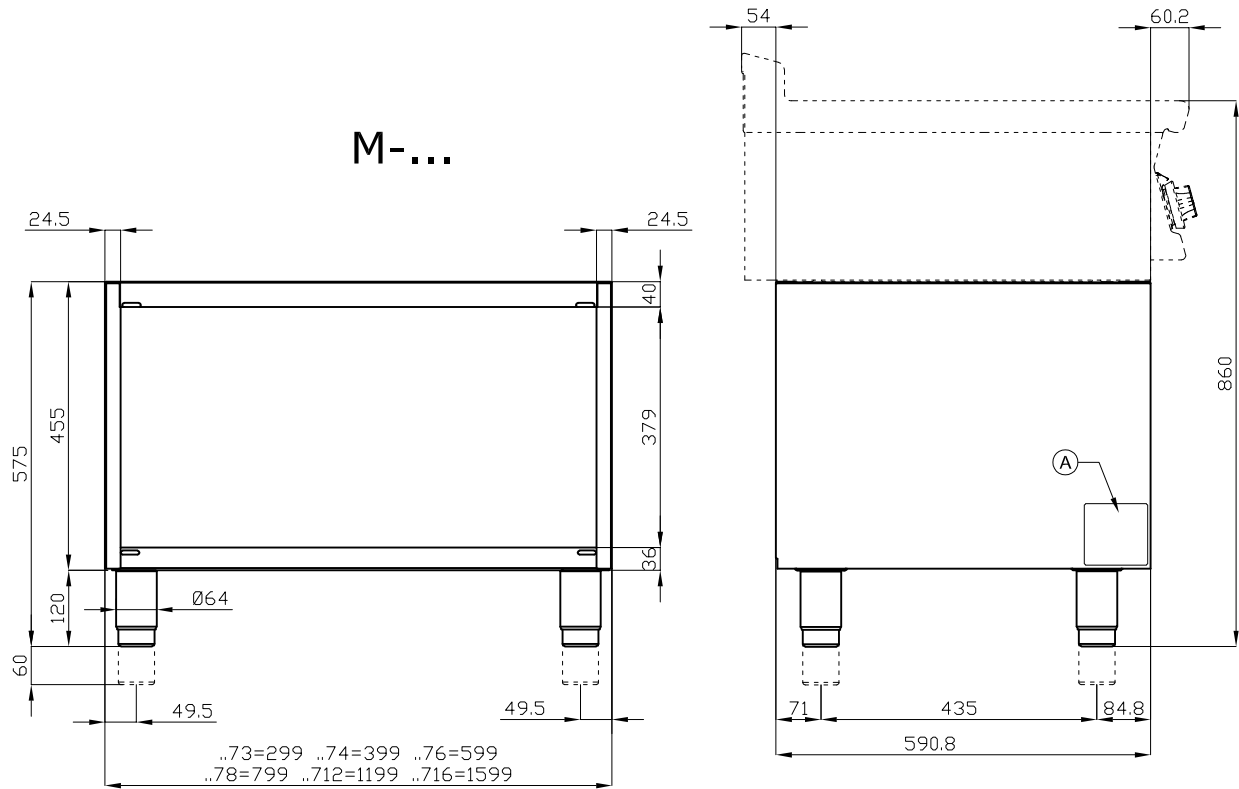

A	Data plate				
---	------------	--	--	--	--

MODEL: M-712  
 DIMENSIONS: cm. 120x 59,5x 57h

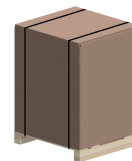

kg: 35  
 m<sup>3</sup>: 0.403  
 mm: 830x770x630

BUY LOTUS BUY ITALY

The pictures are purely representative. The manufacturer reserves the right to modify the technical data and models without previous notice.



LOTUS S.P.A. Via Calmaor, 46  
 31020 San Vendemiano (TV) - Italy  
 Tel. + 39 0438 778020 / 778468  
 Fax + 39 0438 778277  
 www.lotuscookers.it - lotus@lotuscookers.it