

M-10

65 MAGICPROF STAND

Open stand

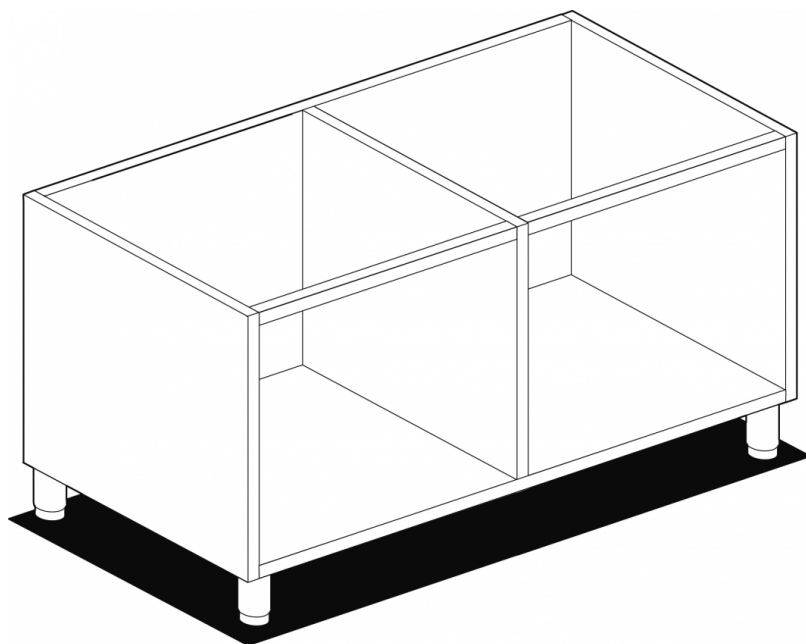

Construction - Fabricated using CrNi 18/10 AISI 304 grade Stainless Steel
Scotch-Brite Satin polish Finish, rounded edges. Model - Professional
Stand and Worktop Units. Fittings - Appliance is supplied with
adjustable feet.



ITALIAN CULINARY ART

The pictures are purely representative. The manufacturer reserves the right to modify the technical data and models without previous notice.

M-10

65 MAGICPROF STAND

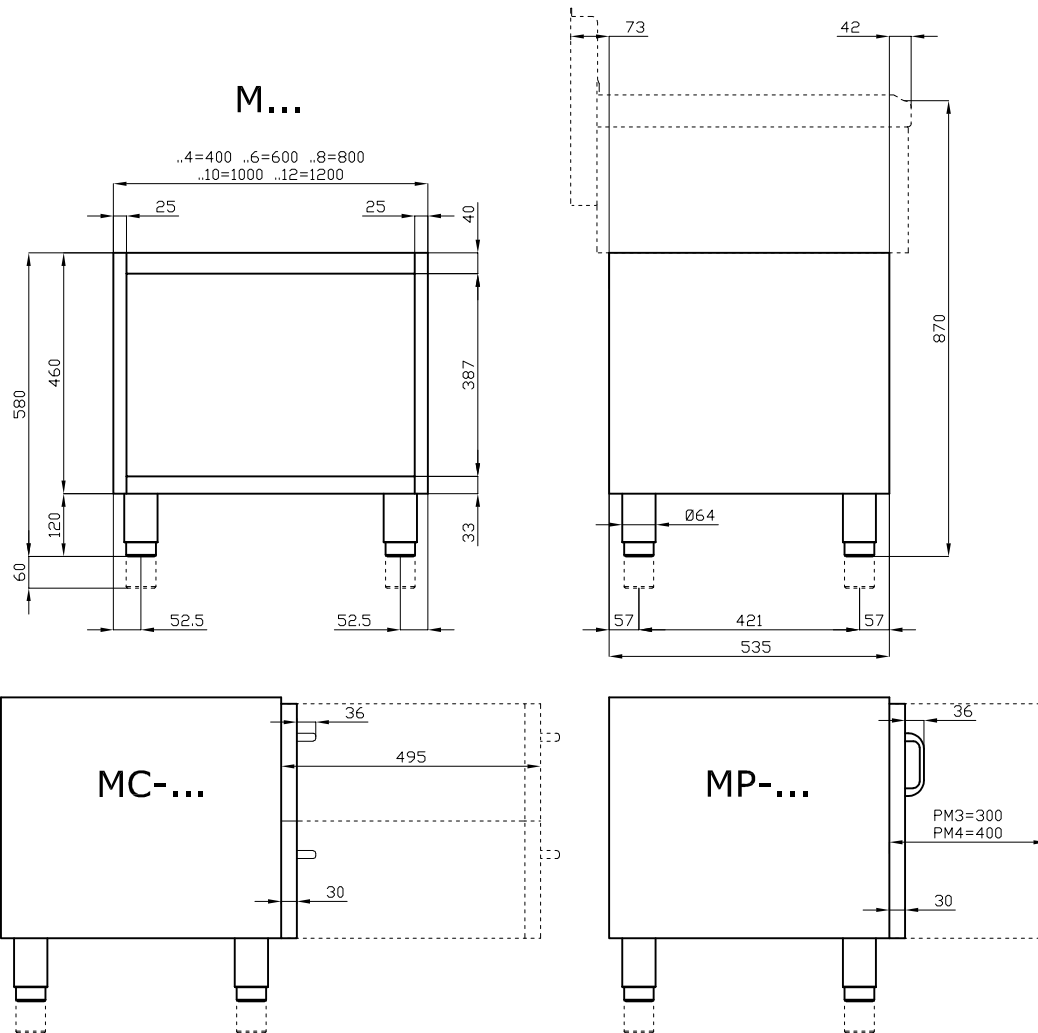

A	Data plate				
---	------------	--	--	--	--

MODEL: M-10
DIMENSIONS: cm. 100x 53,5x 58h

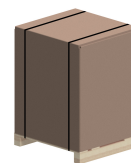

kg: 27
m³: 0.389
mm: 1030x600x630

BUY LOTUS BUY ITALY

The pictures are purely representative. The manufacturer reserves the right to modify the technical data and models without previous notice.



LOTUS S.P.A. Via Calmaor, 46
31020 San Vendemiano (TV) - Italy
Tel. + 39 0438 778020 / 778468
Fax + 39 0438 778277
www.lotuscookers.it - lotus@lotuscookers.it