

# KE-10S

EXTRACTOR HOODS

WALL HOODS WITH MOTOR K

Wall hood complete of motor, speed-control and light. 1200 mc/h



Construction - Fabricated using CrNi 18/10 AISI 304 grade Stainless Steel Scotch-Brite Satin polish Finish. Model - Professional wall direct hood. Ideal for cooking line serie 60/70. Version with motor, light and speed variator. Maintenance - Easy removal of filters. Fittings - Appliance is supplied with labyrinth filters. Coupling flange. Condensate drain.



ITALIAN CULINARY ART

The pictures are purely representative. The manufacturer reserves the right to modify the technical data and models without previous notice.

# KE-10S

EXTRACTOR HOODS

WALL HOODS WITH MOTOR K

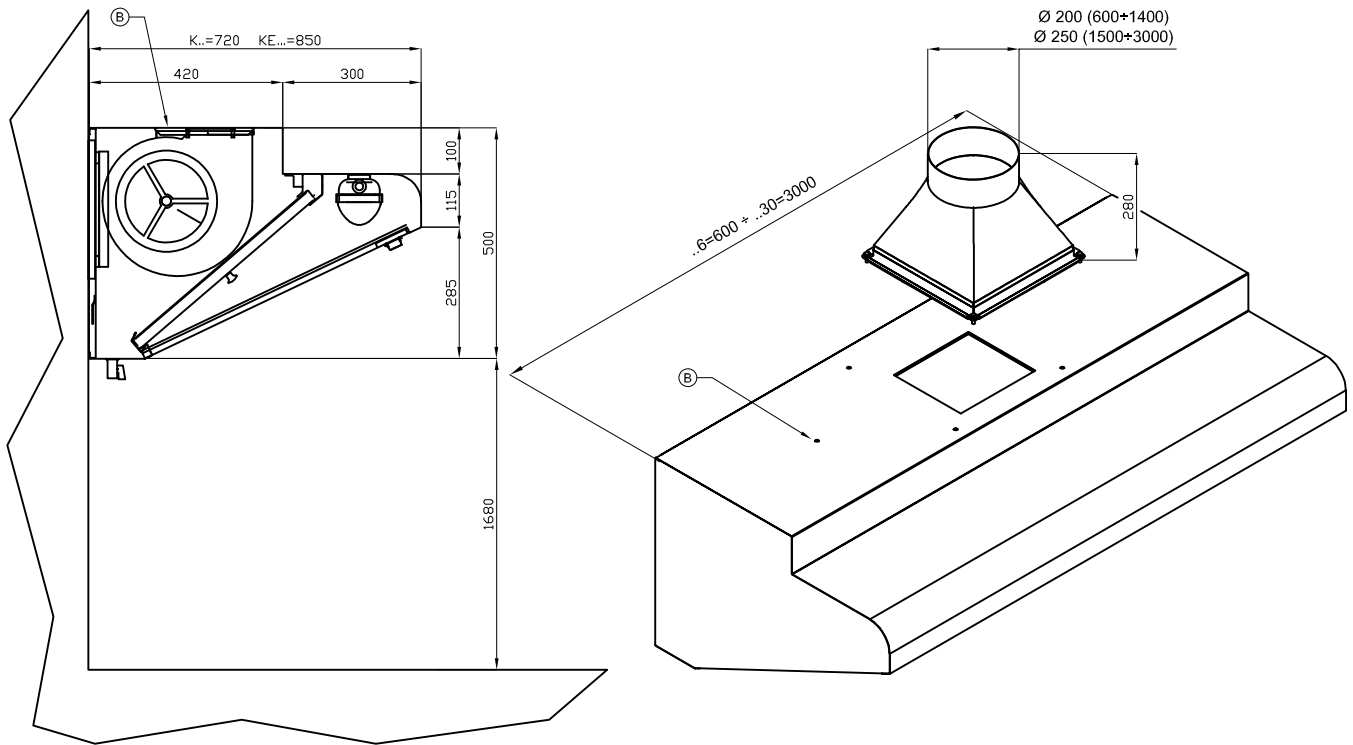

A	Data plate	B	Electrical connection
---	------------	---	-----------------------

MODEL: KE-10S  
DIMENSIONS: cm. 100x 85x 50h  
ELECTRIC POWER: 0,570 kW  
VOLTAGE: 230V~  
FREQUENCY: 50/60 Hz



kg: 42  
m<sup>3</sup>: 0.61  
mm: 1050x570x1020

BUY LOTUS BUY ITALY

The pictures are purely representative. The manufacturer reserves the right to modify the technical data and models without previous notice.



LOTUS S.P.A. Via Calmaor, 46  
31020 San Vendemiano(TV) - Italy  
Tel. + 39 0438 778020 / 778468  
Fax + 39 0438 778277  
www.lotuscookers.it - lotus@lotuscookers.it