

K-6S

EXTRACTOR HOODS

WALL HOODS WITH MOTOR K

Wall hood complete of motor, speed-control and light. 900 mc/h



Construction - Fabricated using CrNi 18/10 AISI 304 grade Stainless Steel Scotch-Brite Satin polish Finish. Model - Professional wall direct hood. Ideal for cooking line serie 60/70. Version with motor, light and speed variator. Maintenance - Easy removal of filters. Fittings - Appliance is supplied with labyrinth filters. Coupling flange. Condensate drain.



ITALIAN CULINARY ART

The pictures are purely representative. The manufacturer reserves the right to modify the technical data and models without previous notice.

K-6S

EXTRACTOR HOODS

WALL HOODS WITH MOTOR K

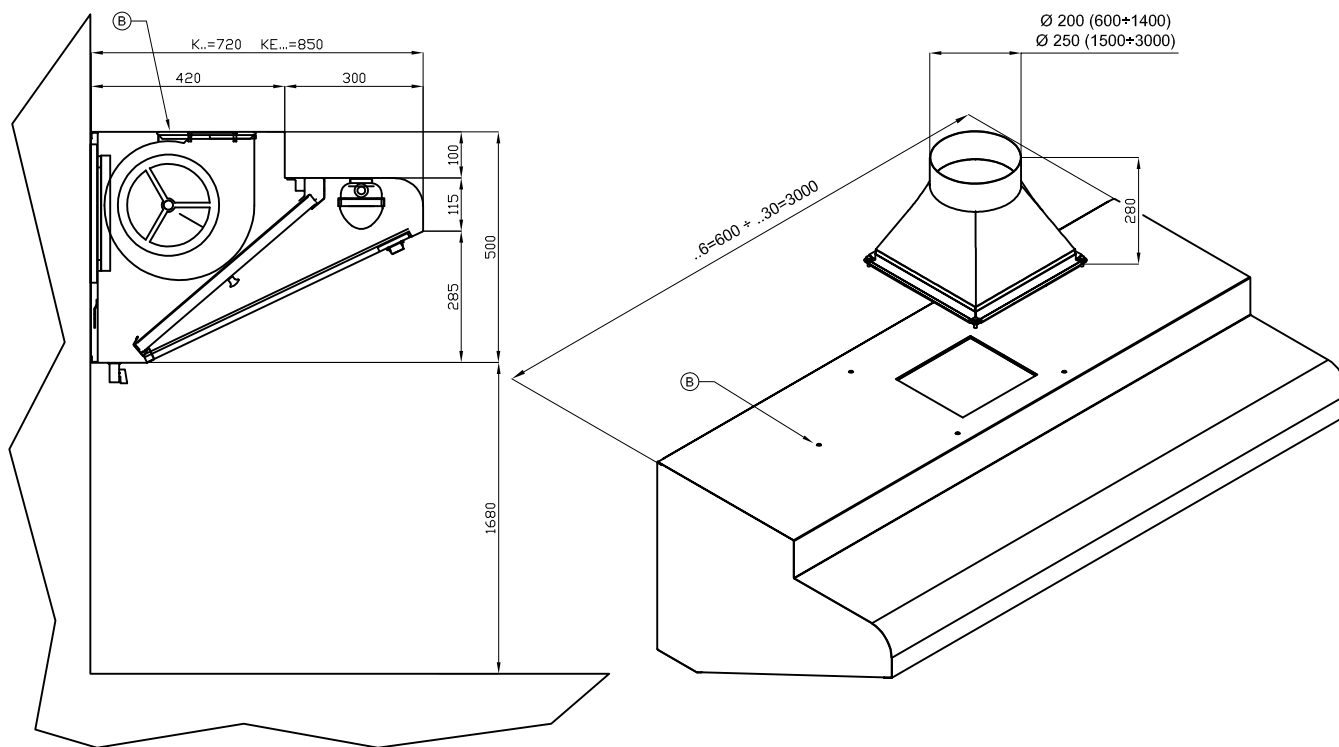

A	Data plate	B	Electrical connection
---	------------	---	-----------------------

MODEL: K-6S
DIMENSIONS: cm. 60x 72x 50h
ELECTRIC POWER: 0,563 kW
VOLTAGE: 230V~
FREQUENCY: 50/60 Hz



kg: 35
m³: 0.33
mm: 650x570x890

BUY LOTUS BUY ITALY

The pictures are purely representative. The manufacturer reserves the right to modify the technical data and models without previous notice.



LOTUS S.P.A. Via Calmaor, 46
 31020 San Vendemiano(TV) - Italy
 Tel. + 39 0438 778020 / 778468
 Fax + 39 0438 778277
www.lotuscookers.it - lotus@lotuscookers.it