

K-30

EXTRACTOR HOODS WALL HOODS K

Wall hood without motor

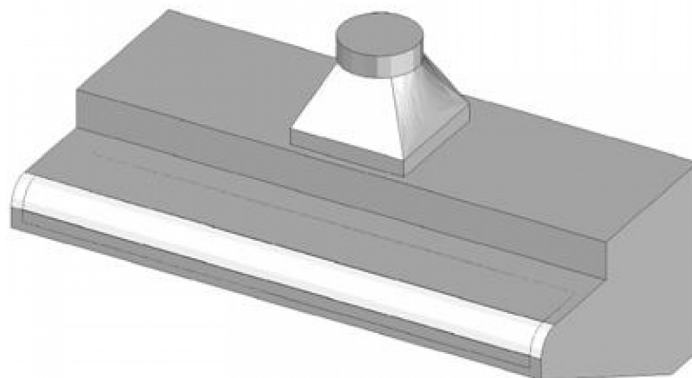

Construction - Fabricated using CrNi 18/10 AISI 304 grade Stainless Steel Scotch-Brite Satin polish Finish. **Model** - Professional wall direct hood. **Ideal for cooking line serie 60/70. Neutral version without motor.**
Maintenance - Easy removal of filters. **Fittings** - Appliance is supplied with labyrinth filters. **Coupling flange. Condensate drain.**



ITALIAN CULINARY ART

The pictures are purely representative. The manufacturer reserves the right to modify the technical data and models without previous notice.

K-30

EXTRACTOR HOODS WALL HOODS K

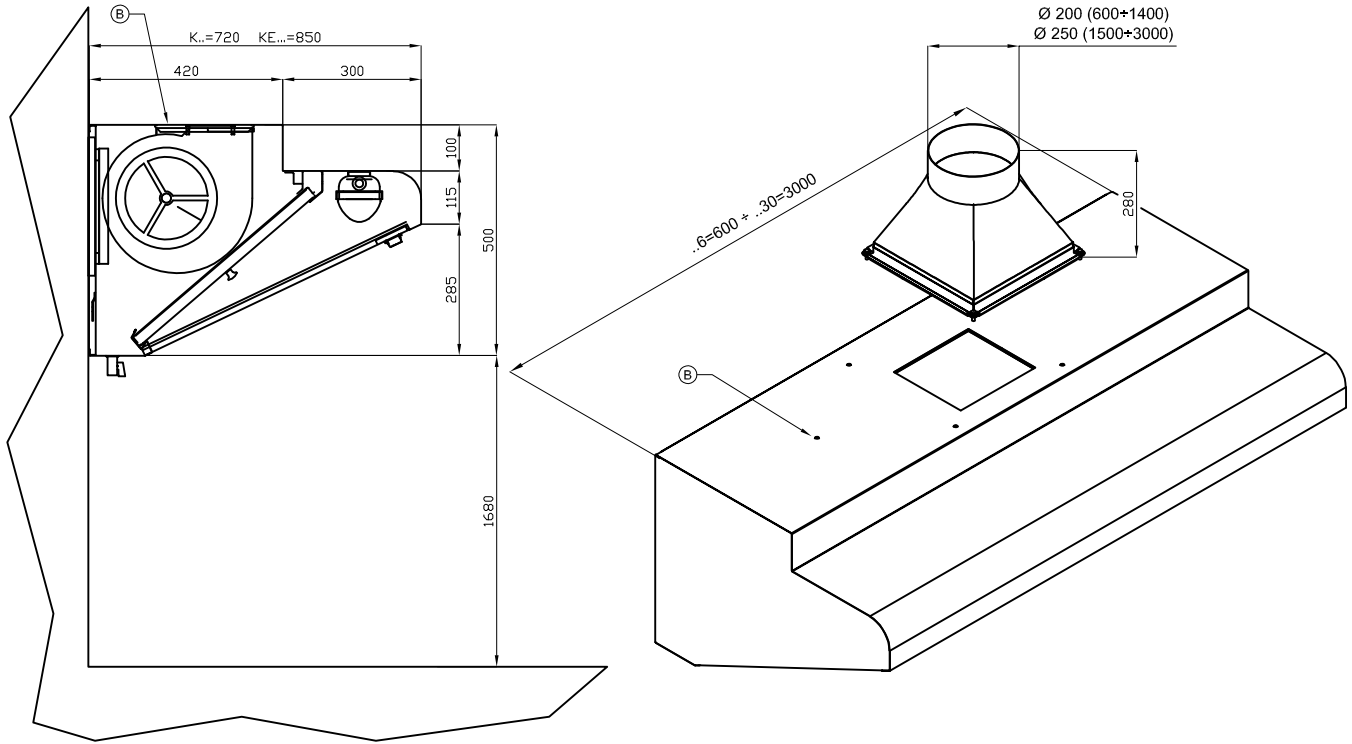

A	Data plate				
---	------------	--	--	--	--

MODEL: K-30
DIMENSIONS: cm. 300x 72x 50h



kg: 64
m³: 1.547
mm: 3050x570x890

BUY LOTUS BUY ITALY

The pictures are purely representative. The manufacturer reserves the right to modify the technical data and models without previous notice.



LOTUS S.P.A. Via Calmaor, 46
31020 San Vendemiano(TV) - Italy
Tel. + 39 0438 778020 / 778468
Fax + 39 0438 778277
www.lotuscookers.it - lotus@lotuscookers.it