

CF4-68G

60 MAGICLOTUS GAS COOKERS



View 3D

Gas range - N. 4 burners - Gas static oven
with grill cm. 64x39x35h, temp: 125÷275°C,
with 1 grid cm.53x32,5 GN1/1 - Stainless
steel door



Construction - Fabricated using CrNi 18/10 AISI 304 grade Stainless Steel Scotch-Brite Satin polish Finish, incorporating 1mm thick worktop, rounded edges, chromed details and rear splash back. Knobs with waterproof grades IPX5. Model - Professional Gas Cooker with static gas oven, with or without side compartment. Burners with electric ignition (CF2/CF3 with pilot light ignition) and thermocouple safety valves. Modulating flame burners, grills in cast iron, removable liquid collectors. Piezoelectric ignition oven for CF2/CF3. Oven with 150-300degC control, thermocouple safety valves. Maintenance - All serviceable parts are accessible by the easy removal of front control panel and liquid collectors. Fittings - Appliance is supplied with both LPG and Natural Gas conversion jets and adjustable feet.

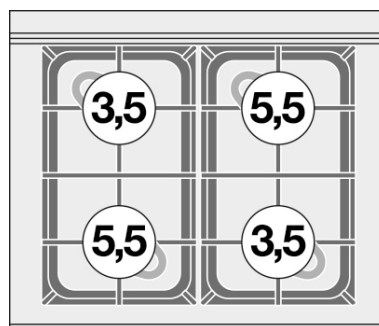

ITALIAN CULINARY ART

The pictures are purely representative. The manufacturer reserves the right to modify the technical data and models without previous notice.

CF4-68G

60 MAGICLOTUS
GAS COOKERS



View 3D

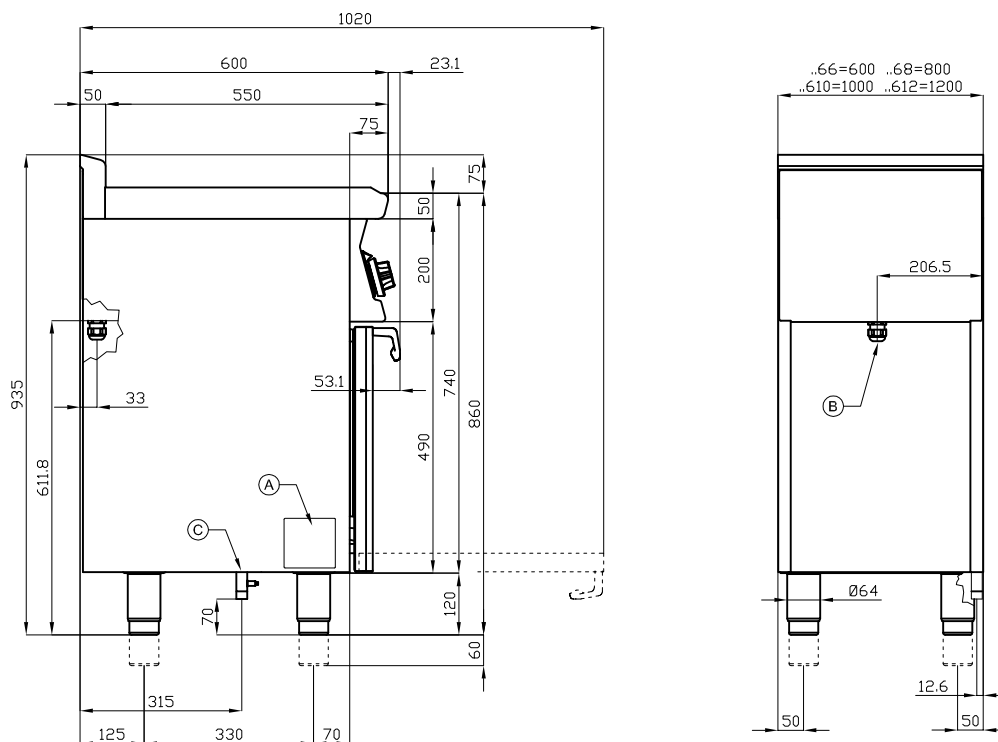

A	Data plate		B	Electrical connection	
C	Gas connection	ISO 7-1 1/2" M			

MODEL: CF4-68G
 DIMENSIONS: cm. 80x 60x 90h
 GAS POWER: 22 kW / 18.920 kcal/h
 GAS TYPE: Natural Gas / LPG
 ELECTRIC POWER: 0,015 kW
 VOLTAGE: 230V~
 FREQUENCY: 50/60 Hz



kg: 97
 m³: 0.617
 mm: 830x670x1110

BUY LOTUS BUY ITALY

The pictures are purely representative. The manufacturer reserves the right to modify the technical data and models without previous notice.



LOTUS S.P.A. Via Calmaor, 46
 31020 San Vendemiano(TV) - Italy
 Tel. + 39 0438 778020 / 778468
 Fax + 39 0438 778277
 www.lotuscookers.it - lotus@lotuscookers.it