

Installation and use instructions

DIRECT COOKING ELECTRIC GRILL FOR PROFESSIONAL USE

**CWK-94ETT CWK-98ETT
Model LIBR.ISTR.S90D CWK-ETT**

Code 5630605A0

Review 1

Edition date 13/11/2024

Language English

LOTUS S.p.A.

Via Calmaor, 46

31020 San Vendemiano

+39 0438 778020

+39 0438 778277

Contents

1	INTRODUCTION	3
1.1	Installation drawing	3
1.2	Example installation of the appliance.....	6
2	GENERAL INFORMATION	7
2.1	Declaration of compliance.....	7
2.2	User information, RAEE Directive on waste electrical and electronic equipment	8
2.3	Technical data table	8
3	INSTALLATION	11
3.1	Delivery checks	11
3.2	Removing the packaging	11
3.3	Mechanical installation	11
3.4	Electrical/gas connections	11
4	INSTRUCTIONS FOR USE	14
4.1	General information	14
4.2	CWK Touch Line display	14
4.3	QR CODE USER MANUAL	14
4.4	Bowl emptying.....	14
4.5	Observations and advice	15
5	MAINTENANCE	16
5.1	Routine.....	16
5.2	Spare parts	16
6	CLEANING	18
6.1	Routine cleaning.....	18

1 INTRODUCTION

1.1 Installation drawing

FIG. 1 CWK-94ETT CWK-98ETT

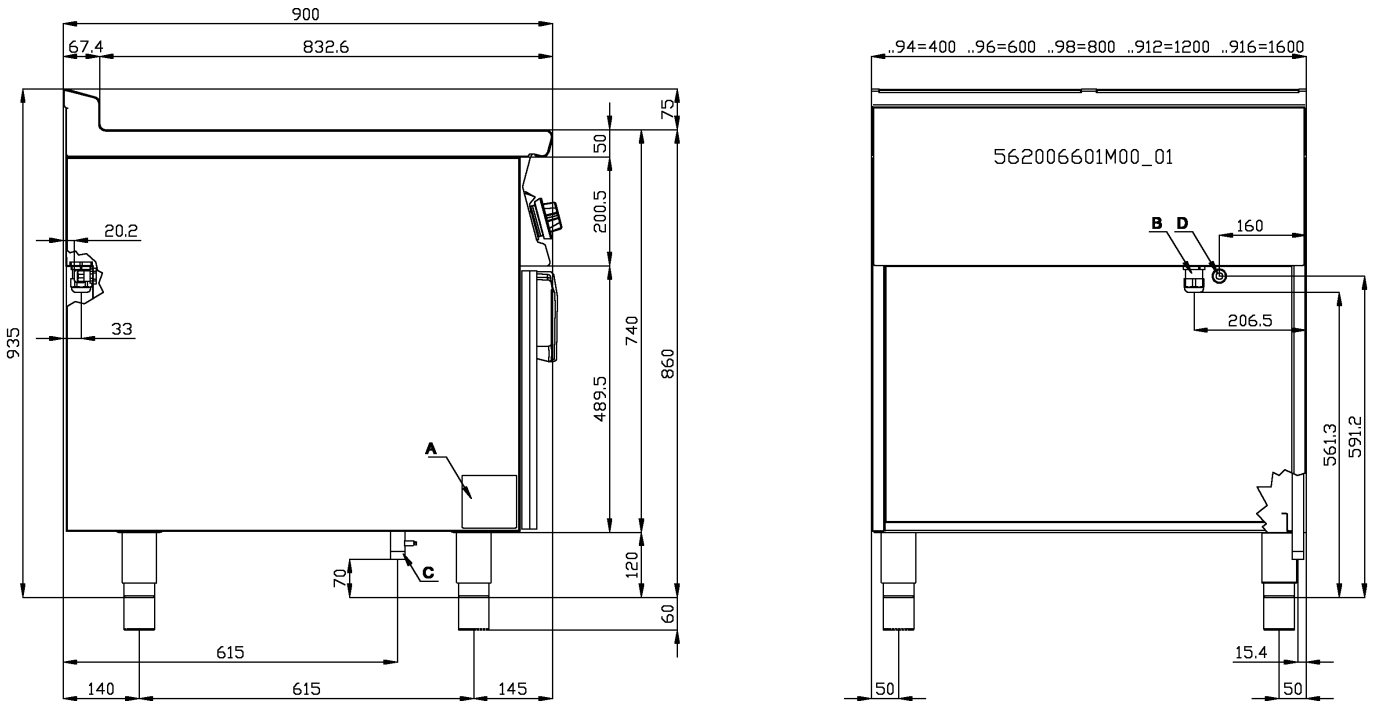

- A Data Plate
- B Electrical connection
- D Energy saving connection

FIG. A WIRING DIAGRAM CWK-94ETT CWK-98ETT

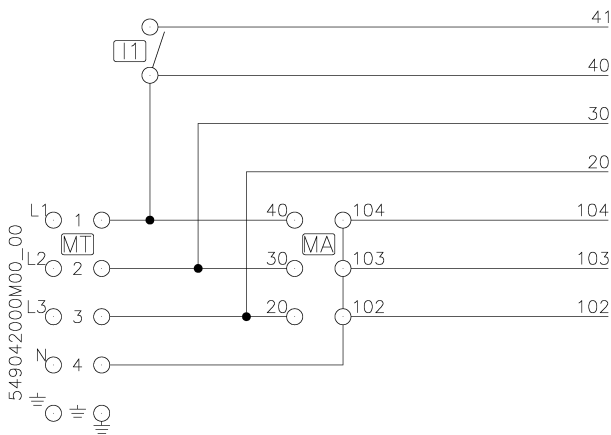
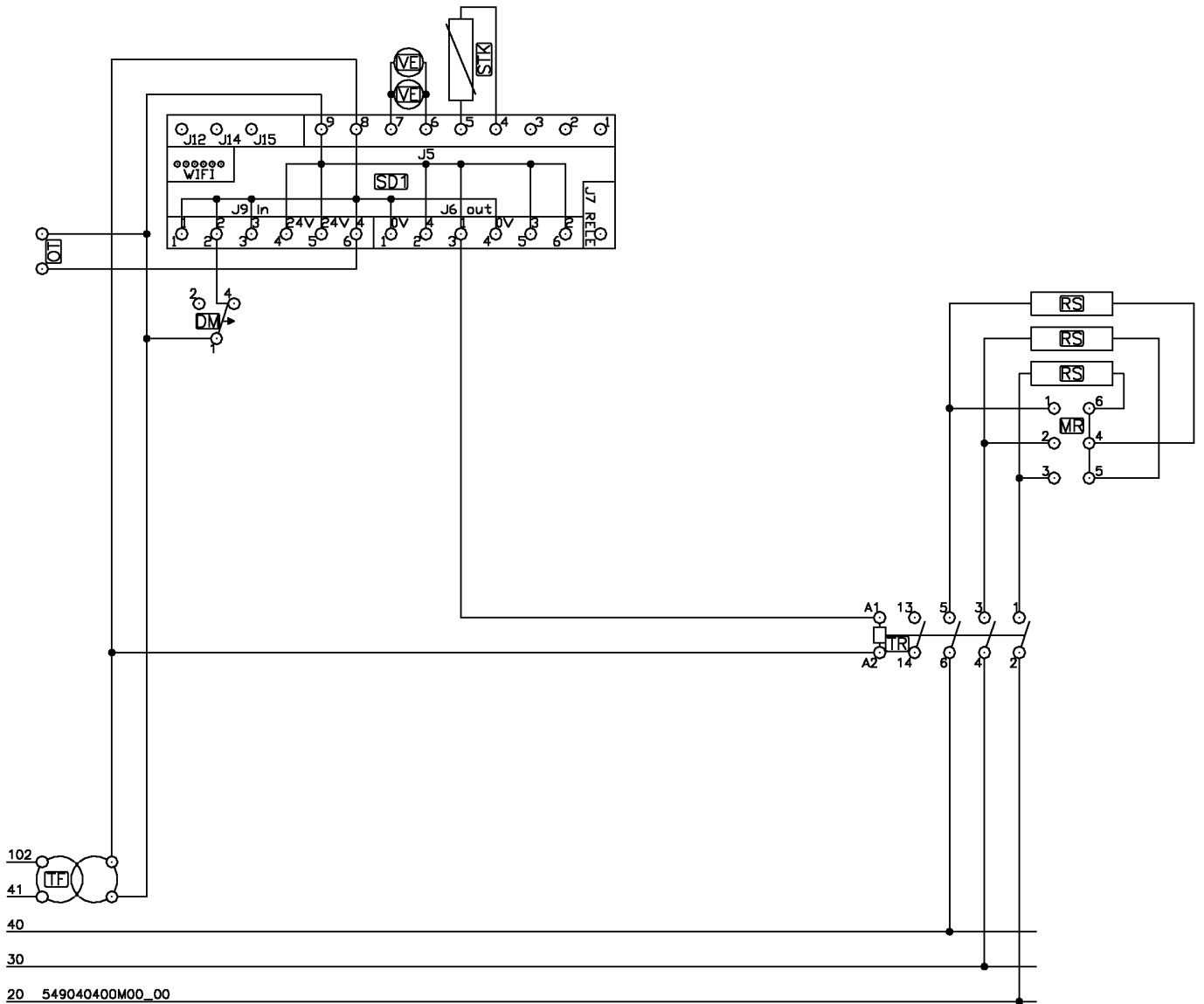

400V~3N 50/60 Hz

Electrical technical data table

DM	Microswitch
MA	Power switching terminal block
I1	Single-pole switch
MR	Resistance switching terminal block
OT	Optimiser connection
MT	Three-phase power supply terminal block
SD1	Digital control board
VE	Fan
STK	K-type thermocouple temperature probe
TF	Transformer
MR	Resistance switching terminal block
RS	Resistance

MODELS	FIG.A
CWK-94ETT	A
CWK-98ETT	A + A

1.2 Example installation of the appliance

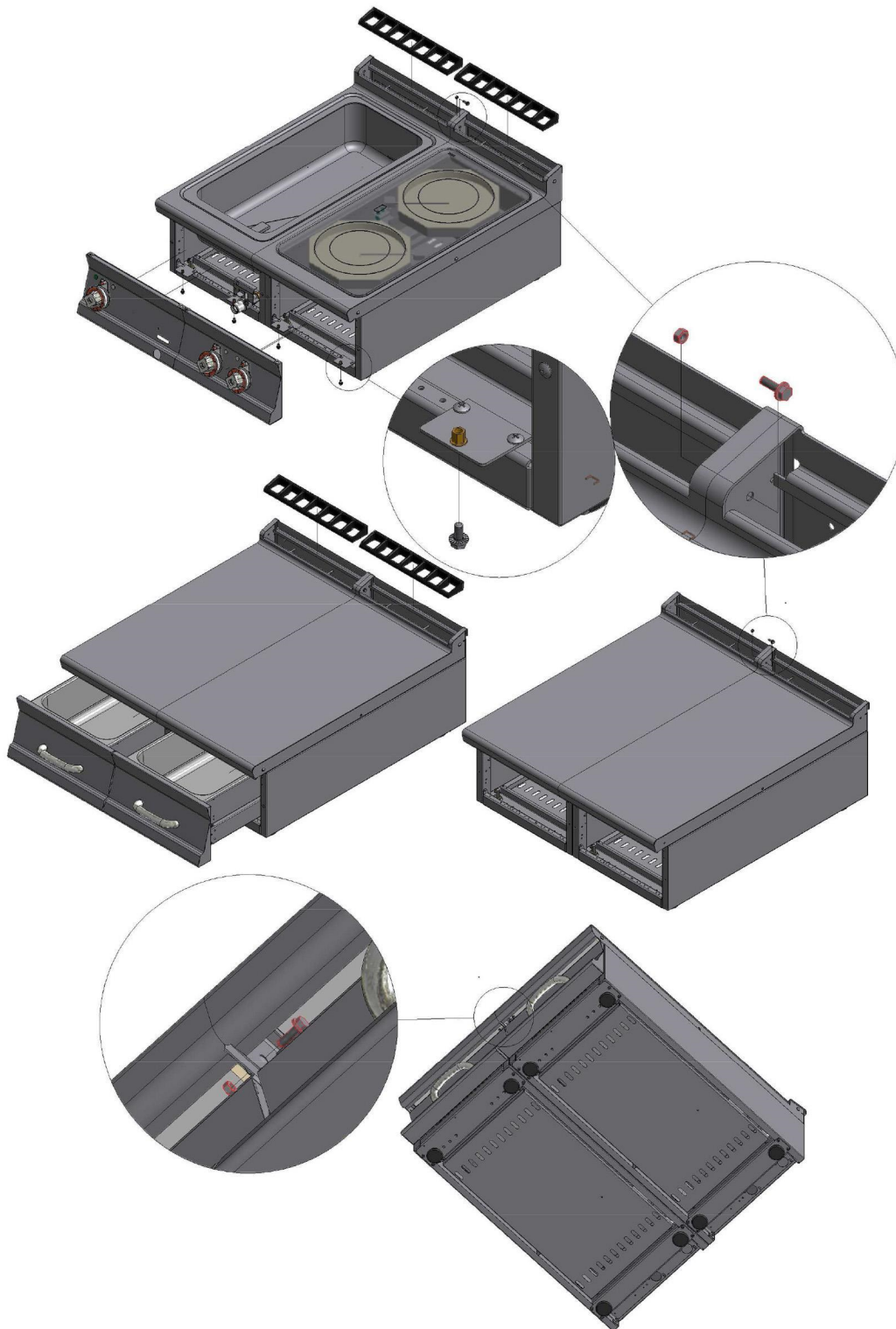

562026000M00P00.idw 1 di 1

2 GENERAL INFORMATION

2.1 Declaration of compliance

The manufacturer declares that the appliances comply with the requirements of the regulation GAR 2016/426 for the gas part and directive 2014/30/EU, 2014/35/EU for the electrical part. Installation must be performed in compliance with current regulations, especially with regard to ventilation of the premises and the exhaust gas evacuation system.

- Read the warnings in this manual carefully. They provide important information about safe installation, use and maintenance.
- The instruction manual must be kept for the entire duration of the equipment and made available to users for every possible consultation. The manual should be consulted for any information concerning installation, use and maintenance of the appliance.
- After removing the packaging, check the integrity of the equipment.
- All packaging materials (plastic bags, polystyrene, staples, etc.) must be disposed of in compliance with current regulations.
- Before connecting the appliance, make sure that the information on the data plate matches the electricity and gas mains where the appliance is installed. **The manufacturer accepts no liability if the equipment is not connected in accordance with current regulations.**
- Always keep all parts of the equipment clean to avoid the risk of oxidation/rust and/or aggression by chemical agents.
- The equipment must only be used by personnel trained for the purpose.
- **The installation must be implemented by professionally qualified personnel in accordance with the manufacturer's instructions and current reference standards.**
- The electrical safety of this equipment is only ensured when it is correctly connected to an effective ground/earth system as required by current electrical safety standards. The manufacturer cannot be held liable for any damage caused if the system is not connected to ground/earth.
- Before carrying out any cleaning or maintenance tasks on the equipment, unplug it from the electricity mains. In the event of faults or malfunctions, always deactivate the appliance.
- **Repair work of any kind must only be performed by qualified personnel.**
- This appliance must only be used for its expressly intended purpose for cooking or heating food. Any other use is considered improper.
- The appliance is intended for professional use and must be used by trained personnel.
- The installation and possible transformation to another power supply voltage (if envisaged), or transformation for operation with another type of gas, must be implemented exclusively by qualified and authorised professional personnel.
- Before using the appliance, carefully clean all surfaces intended to come into contact with food.
- The manufacturer declines any and all liability for any direct or indirect damage resulting from improper use of the equipment. The manufacturer declines any and all liability for damage caused by incorrect installation, tampering, poor maintenance and unskilled use. Moreover, the manufacturer declines any liability for possible inaccuracies that may be contained in this booklet attributable to errors in transcription or printing and equally reserves the right to make any changes to the product it deems useful and/or necessary without compromising its essential characteristics.
- **The manufacturer cannot be held liable for any damage caused by failure to comply with these basic standards and all other use and maintenance standards contained in this booklet.**

2.2 User information, RAEE Directive on waste electrical and electronic equipment

With regard to the regulatory framework of reference of the European Community, we remind the user of the following:

- Used AAE (Electrical and Electronic Equipment) products must be collected separately
- The user can carry out this collection in the RAEE collection systems and return the equipment to the distributor when purchasing a new one
- Plus being RoHS compatible, (in accordance with Directive 2011/65/EU on the restriction of the use of certain hazardous substances in electrical and electronic equipment) the potential effects on the environment and human health may be due to the misuse of the same equipment or parts of it
- The symbol  next to the rating plate indicates the obligation of separate collection
- The penalties provided for in the event of improper disposal of RAEE (Waste Electrical and Electronic Equipment) are those provided for by the national transpositions of European Directives 2012/19/EU

2.3 Technical data table

Technical data table CWK S90ETT

MODEL	DIMENSION S	POWER SUPPLY	MAXIMUM ABSORPTION (A)	MAXIMUM POWER (kW)	WATER CONSUMPTION ON BASIN (litres) Approximate	POWER CABLE silicon type
CWK-94ETT	40x90x90h	400V~3N 50/60 Hz	7,8	5,4	1lt/h	5 x 1,5 mm ²
CWK-98ETT	80x90x90h	400V~3N 50/60 Hz	15,63	10,8	1lt/h	5 x 2,5 mm ²

Table of parameters CWK-9..ETT

PARAMETER ID	ID code	DESCRIPTION	Adjustment field	U.M.	Resol.	CWK
1	MAX temp.	Maximum temperature	50 - 400	°C	1	
2	Fan temp. setting	NTC temperature for cooling fan(s) start-up	0-50	°C	1	35
3	Cooling fan	Enabling of instrument compartment cooling fan(s) start-up: 0=always off 1=always on 2=as in parameter 2	0-2	K	1	2
4	Func.key sens.	Sensitivity to key pressing on capacitive touch. Defines how long each key must be held down for the control to accept the input.	1-100	msec.	1	10
5	Time scale	Modifies the evolution of timer/delay times. If set at "0", the times are real. If set at "1", the times are accelerated 10-fold.	0-1	K	1	0
6	Temp. CTRL hysteresis	Working hysteresis (in relation to the Set Point) - degrees below setting for the temperature control of heating elements in the 7-CPA pasta cooker (disconnection at 0)	0-10	°C	1	
7	Corr. factor Probe1	Multiplication factor of the upper plate thermocouple reading in the Frytop 8-FT and the multifunction Top-plate 13-TPK	0,50 - 1,00	K	0,01	
8	Corr. factor Probe2	Multiplication factor of the lower plate thermocouple reading in the multifunction Top-plate 13-TPK	0,50 - 1,00	K	0,01	
9	Water loading times	Loading seconds for the 3 slow top-up speeds, 1/2/3 on a 60Sec basis 1=36/48/60 2=33/45/60 3=24/42/60	1-3	K	1	
10	EXPO	Fair or showroom mode 0=normal work functions 1=functions in ECO and single-phase connection available	0-1	K	1	0
11	PID out. vis.	If set at "1", enables the visualisation on the display of the calculated values of the 3 PID constants	0-1	K	1	
12	PID KP	Proportional PID constant	0-20	K	1	
13	PID KI	Integral PID constant	0-20	K	1	
14	PID KD	Derivative PID constant	0-40	K	1	
15	PID TR	Recalculation time for PID constants	0,5 - 60,0	sec.	0.1	

PARAMETER ID	ID code	DESCRIPTION	Adjustment field	U.M.	Resol.	CWK
16	MaxOut PID_I	Calculation limit of the PID KI constant. % referring to the PID TR (15) and defines the maximum value of the ON time component, calculated from the Integrative component alone.	20 - 80	%	1	
17	PID Work Band	Working range (above and below the Set Point) of the PID action. % of the Set Point value	0-50	%	1	
18	Minimum Ton-Toff	Minimum switch-on and switch-off time of heating element command outputs. % of the PID TR (15)	5-25	%	1	
19	Time er04	Sampling time for checking the rising temperature variation, set in parameter 20	0-500	sec.	1	
20	T. delta er04	Temperature differential to be checked in the time set in parameter 19. If set at "0", the "er04" error check is DISABLED	1-20	°C	1	
21	Time av01	Sampling time for checking the negative temperature variation, set in parameter 22	0-10	sec.	1	
22	T. delta av01	Negative temperature differential to be checked in the time set in parameter 21	1-60	°C	1	
23	Time av02	Sampling time for checking the positive temperature variation, set in parameter 24	0-10	sec.	1	
24	T. delta av02	Positive temperature differential to be checked in the time set in parameter 23	1-60	°C	1	
25	Time av03	Sampling time for input 2 status: component raised	0-60	sec.	1	30

3 INSTALLATION

3.1 Delivery checks

On delivery, it is important to check the following:

- External conditions of the packaging
- The general status of the equipment
- The conformity of the model with the information in the technical data plate and the instruction manual
- The conformity of the equipment and components to the order form

3.2 Removing the packaging

While removing the packaging, take care not to damage the appliance. Remove the protective film from the stainless steel and eliminate any traces of glue. Do not smoke. Perform this operation away from sources of heat and wear protective gloves. Do not disperse packaging material in the environment, keep it out of the reach of children and dispose in compliance with current legislation.

3.3 Mechanical installation

Place the appliance on a flat base. Adjust and stabilise the appliance by acting on the support feet. Make sure that the surrounding walls and/or equipment are capable of withstanding the heat emitted by this appliance. Connect the water supply (if necessary).



Caution

Do not install the appliance near equipment/machines used in cold processes. If the appliance has to be installed close to cold process equipment, it is advisable to install non-combustible thermal insulating material and/or neutral elements between them.

3.4 Electrical/gas connections

Before being offered for sale on the market, the appliance was subjected to gas and electrical testing (as required). The appliance is supplied without a power cable. The installation technician must connect the equipment in compliance with current safety regulations on the basis of the power of the appliance.



Note

The ID plate is located in the compartment inside the door for appliances with compartments, or on the left side for appliances with an oven or a top. A second plate with the model and serial number is located inside the dashboard and a third is included with the certificate of conformity. The serial number can also be tracked from the sales document (after 2008). The plate has all the data needed for correct electrical installation. The installation and possible conversion to another power supply voltage (if envisaged) must be implemented exclusively by professionally qualified and authorized personnel. Before using the appliance, carefully clean all surfaces intended to come into contact with food.

Warning

Installation operations, any conversion to other types of gas and start-up must only be performed by qualified personnel, in accordance with current regulations.

Gas systems, electrical connections and premises where the appliances are installed must comply with current regulations in the country of installation; in particular, the appliance must be installed in a room with good ventilation, if possible under a suction hood to ensure complete evacuation of the exhaust gases formed during combustion. The air required for combustion is 2 m³/h per kW of installed power. The appliance can be installed alone or in series with other appliances in our production range. A minimum distance of 10 cm between appliances must be respected to prevent contact with any walls made of flammable material; furthermore, appropriate measures should also be adopted to ensure the thermal insulation of flammable parts, such as the installation of heat shields; take special care to ensure that appliances are installed in an appropriate and safe manner. The support feet can be adjustable in height and any unevenness can therefore be eliminated.

ELECTRICAL CONNECTION

Caution

For direct connection to the grid, a device must be provided to ensure disconnection from the grid, with a contact opening distance that allows complete disconnection under overvoltage category III conditions, in accordance with the installation rules

The connection terminal is located behind the rear wall. Proceed as follows to install the power supply cable:

- Remove the rear panel.
- Pass the new connection cable through the cable gland, connect the leads to the corresponding terminal on the terminal block and fasten them securely.
- Lock the cable with the cable gland and refit the panel. The earth/ground lead must be longer than the others so that if the cable gland breaks it is disconnected after the power cables.

Note

Make sure that the mains voltage complies with the data on the appliance's ID plate and that there is good conductivity to earth/ground. Pay attention when inserting leads to ensure they do not obstruct the normal course of work and routine appliance cleaning operations. Also make sure that the power cable is never pulled taut and is not placed in contact with sources of heat.

Note

The connection cable must have the following characteristics: it must be silicone type (to withstand temperatures of 180 °C), and must have an appropriate cross-section for the power of the appliance (see technical data table).

EQUIPOTENTIAL

The appliance must be connected to an equipotential system. The connecting screw is located on the rear of the appliance and is marked by the yellow symbol above it.



Warning

The manufacturer is not liable for and does not indemnify damages caused by incorrect inadequate installations that do not comply with these instructions.

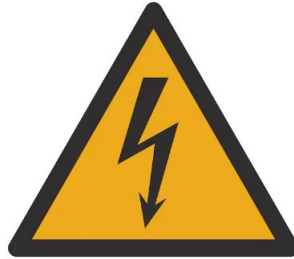

Caution

ALL PARTS THAT GIVE ACCESS TO LIVE PARTS AFTER REMOVAL ARE MARKED WITH THE "WARNING: DANGEROUS VOLTAGE" SYMBOL



4 INSTRUCTIONS FOR USE

4.1 General information

This appliance must only be used for its expressly intended purpose for cooking or heating food. Any other use is considered improper. The appliance is also intended for industrial use and **must only be used by personnel trained for use and aware of the risks that the hot element entails.**



Warning

The appliance operates at high temperatures, so the following is necessary:

- **Pay attention to the areas surrounding the hot surface during routine normal operation (danger of scalding);**
- **RISK OF BURNS Do not touch hot surfaces floor with your hands or other parts of the body to avoid burns caused by high temperatures;**
- **After switching off the appliance, wait for a sufficient time for it to cool before carrying out any cleaning or maintenance operation.**

4.2 CWK Touch Line display

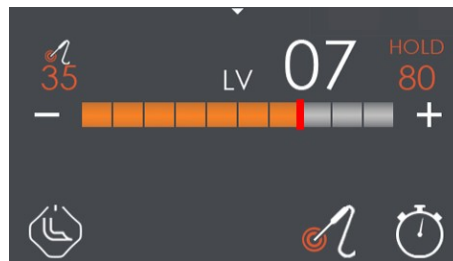
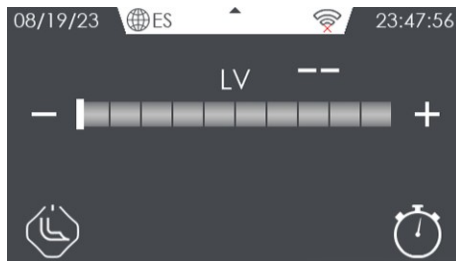

4.3 QR CODE USER MANUAL

For the user instructions, refer to the 5630613A0ENNN DIGITAL LINE USER MANUAL by scanning the QR CODE below:



https://www.lotuscookers.it/documenti_new/libretti/5630613A0ENNN.pdf

4.4 Bowl emptying

To empty the bowl of the cooking residuals, apply the drain extension and open the valve located on the front panel of the appliance. The operator must use a container that is suitable for this operation

4.5 Observations and advice

- In the case of appliances with two cooking zones, it is possible to set different temperatures on the two halves of the plate, or use only one half.



Caution

Thermal shocks can damage and PERMANENTLY DEFORM the heating element; defrost the food prior to cooking



Warning

DO NOT USE ABRASIVE OR CORROSIVE DETERGENTS, DO NOT CAUSE THERMAL SHOCKS TO THE HEATING ELEMENT WHILE CLEANING IT, DO NOT USE ICE TO CLEAN THE HEATING ELEMENT

5 MAINTENANCE

5.1 Routine

When using the appliance over time, it is essential to perform regular maintenance to ensure safe operation. We therefore recommend stipulating a service contract.



Caution

Maintenance must only be performed by specialist personnel in compliance with current regulations and our own instructions.

Before carrying out any maintenance and/or cleaning operation:

- Disconnect the appliance from the mains power supply and/or close the gas.
- Wait for a sufficient time for the appliance to cool down.
- Do not wash the appliance with direct or high-pressure jets of water, since any infiltration of water into the electrical components could jeopardise correct operation of the appliance and its safety systems.



Warning

For maintenance/replacement of components, order and use only original spare parts.

Replacing parts must exclusively be performed by authorised and/or qualified personnel. When replacing the electrical components of the machine and the electrical panels, scrupulously follow the technical characteristics for the replacement component indicated on the component itself. The appliance does not require any special maintenance but during the use of the equipment it is advisable to check the following at least once a year (possibly increasing the frequency depending on the degree of use):

- The status of connections especially on the terminal board and the power supply cable, as well as the status of the gas connections;
- The operating condition of the various components (perform a functional test);
- For appliances fitted with rotary resistances, remove the hub, grease it and replace the three o-ring seals to avoid possible leaks.

5.2 Spare parts

It is possible to replace parts such as the valve, the piezoelectric or the ignition control unit (depending on the type of appliance) or the gas pipes easily and quickly.

To replace such parts, proceed as follows:

- **HEATING ELEMENT** ; remove the panel and remove the wires connecting the heating element. Unscrew the supports that fasten the heating element to the hob. Once removed, make the replacement.
- **TOUCH BOARD** ; after disassembling the front panel, loosen the two screws securing the touch board to the dashboard. Disconnect all the electrical connections, then replace the board



Caution

WHAT TO DO IN THE EVENT OF FAULTS:

Close the gas connection cock and/or switch off the power using the up-line device. Notify customer service.



Warning

MEASURES TO BE TAKEN IF THE APPLIANCE IS NOT TO BE USED FOR A LONG TIME:

Close the gas cock and/or disconnect the power supply. Clean the system as specified above.

6 CLEANING

6.1 Routine cleaning



Caution

The use of flammable fluids to clean the appliance is forbidden

To ensure hygiene and the durability of the appliance, perform external cleaning on a regular basis, taking care not to damage the cables and the electrical connections. Before starting cleaning, disconnect the appliance from the power supply. Parts in steel can be washed with warm water and a neutral detergent: Rinse them thoroughly to eliminate all traces of detergent and then dry with a dry cloth. Do not use abrasive and corrosive detergents. Enamelled parts must be washed with soapy water. For appliances that included an oven, cleaning it is made easier by removing the support grid. Thorough, daily cleaning prevents faults and accumulated deposits of fat and/or food. The steels used in the manufacture of professional equipment are tried and tested materials of the highest quality. Thanks to their characteristics, they are ideal materials for use with food substances.

Consequently, when using stainless steel appliances, the following suggestions must be observed:

- Stainless steel surfaces must always be kept clean, also ensuring contact with the air. The lack of oxygen under layers of scale, starch, egg white or other deposits means that surfaces can be affected by corrosion
- Do not use products containing salt or sulphuric acid to remove scale. Suitable products are available commercially but a diluted solution of acetic acid can also be used
- To clean STAINLESS STEEL appliances, it is advisable to use detergents specifically formulated for this material. For "minor cleaning", a mild washing up liquid solution may also be used
- **Do not wash the appliance with jets of water under pressure**
- Avoid using detergents containing abrasive powders or bleaches of any kind
- Lockable stainless steel appliances, during periods of inactivity, must be left uncovered so that air can freely access internal metal surfaces
- Stainless steel must not remain in contact for long periods with concentrated acids or with aromatised concentrates such as salt solutions, mustard, spice mixtures or the like. At certain temperatures and concentrations, these substances can damage the passive layer. Contact surfaces must therefore be immediately rinsed with clean water and then dried
- It is inadvisable to use stainless steel pots exclusively to cook foods in salt water (pasta, rice, potatoes, etc.). From time to time, these pots must also be used to cook foods containing fats or vegetables. This helps to prevent damage caused by corrosion
- After cooking foods in salt water, rinse the tanks with fresh water since salt water residues from cooking form layers of highly concentrated saline solution that can cause spotting corrosion
- To prevent so-called secondary corrosion, prolonged contact of stainless steel with ferritic steels should be avoided
- Any secondary corrosion spots must be eliminated immediately
- Do not use sharp objects that may scratch stainless steel parts and consequently give rise to deterioration