

## Installation and operating instructions

# PROFESSIONAL COOKER WITH ELECTRIC OVEN

**PCQ-558ET PCQ-118ET CFQ4-118ET**

**Model LIBR.ISTR.PC CF110E**

**Code 5630513A0**

**Review 1**

**Edition date 06/06/2022**

**Language English**

LOTUS S.p.A.

Via Calmaor, 46

31020 San Vendemiano

+39 0438 778020

+39 0438 778277

# Contents

<b>1</b>	<b>INTRODUCTION</b> .....	<b>3</b>
1.1	Installation drawing .....	3
1.2	Example installation of the appliance.....	8
<b>2</b>	<b>GENERAL INFORMATION</b> .....	<b>9</b>
2.1	Declaration of compliance.....	9
2.2	User information, RAEE Directive on waste electrical and electronic equipment .....	10
2.3	Technical data table .....	10
<b>3</b>	<b>INSTALLATION</b> .....	<b>12</b>
3.1	Delivery checks .....	12
3.2	Removing the packaging .....	12
3.3	Mechanical installation .....	12
3.4	Electrical/gas connections .....	12
<b>4</b>	<b>INSTRUCTIONS FOR USE</b> .....	<b>14</b>
4.1	General information .....	14
4.2	Lighting and adjusting the open rings.....	14
4.3	Turning on and adjusting the static oven .....	15
<b>5</b>	<b>MAINTENANCE</b> .....	<b>16</b>
5.1	Routine.....	16
5.2	Spare parts .....	17
<b>6</b>	<b>CLEANING</b> .....	<b>18</b>
6.1	Routine cleaning.....	18

# 1 INTRODUCTION

## 1.1 Installation drawing

FIG. 1 PCQ-558ET

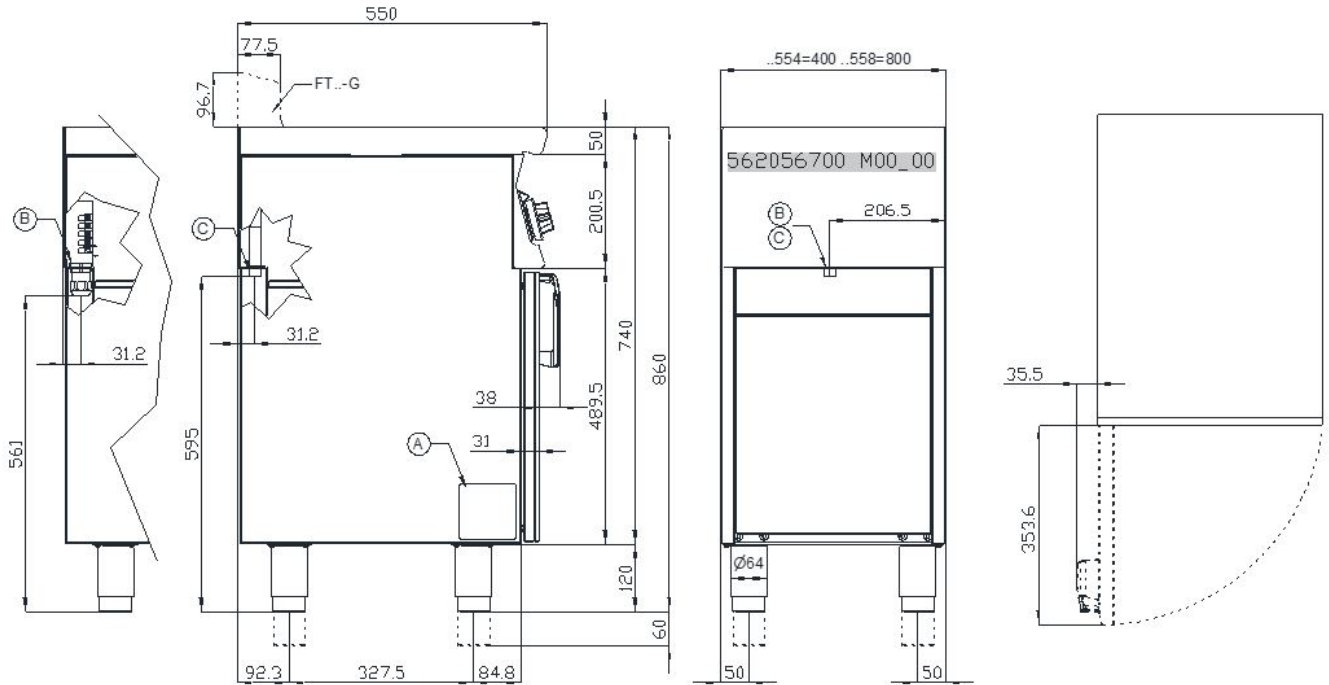

- A Data Plate
- B Electrical connection

**FIG. 2 PCQ-118ET**

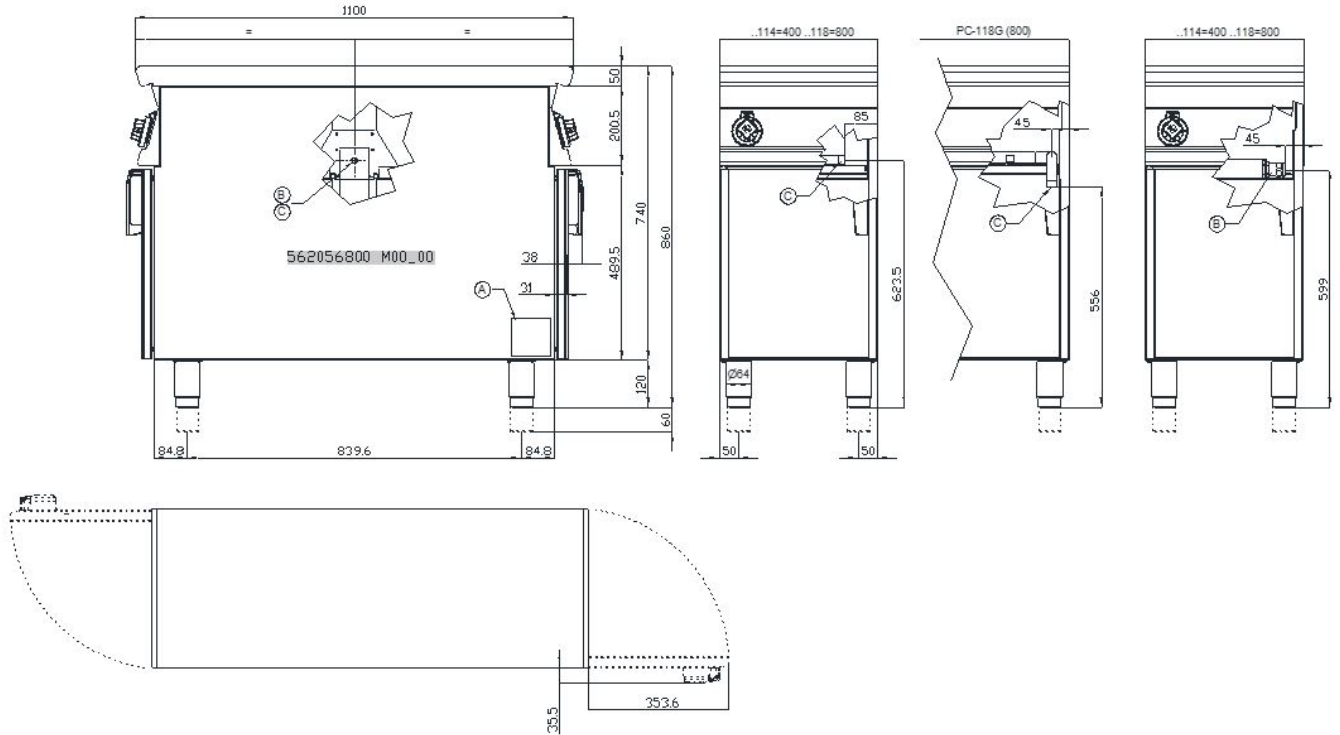

- A Data Plate
- B Electrical connection

**FIG. 3 CFQ4-118ET**

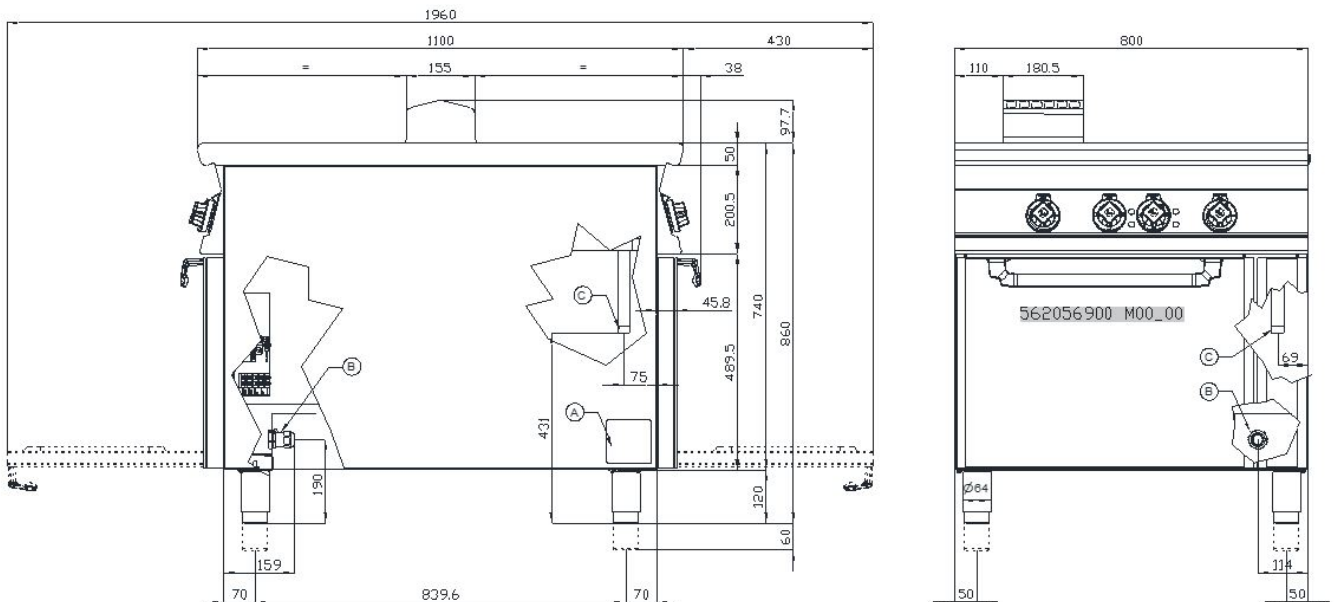

- A Data Plate
- B Electrical connection

WIRING DIAGRAM PCQ-558ET

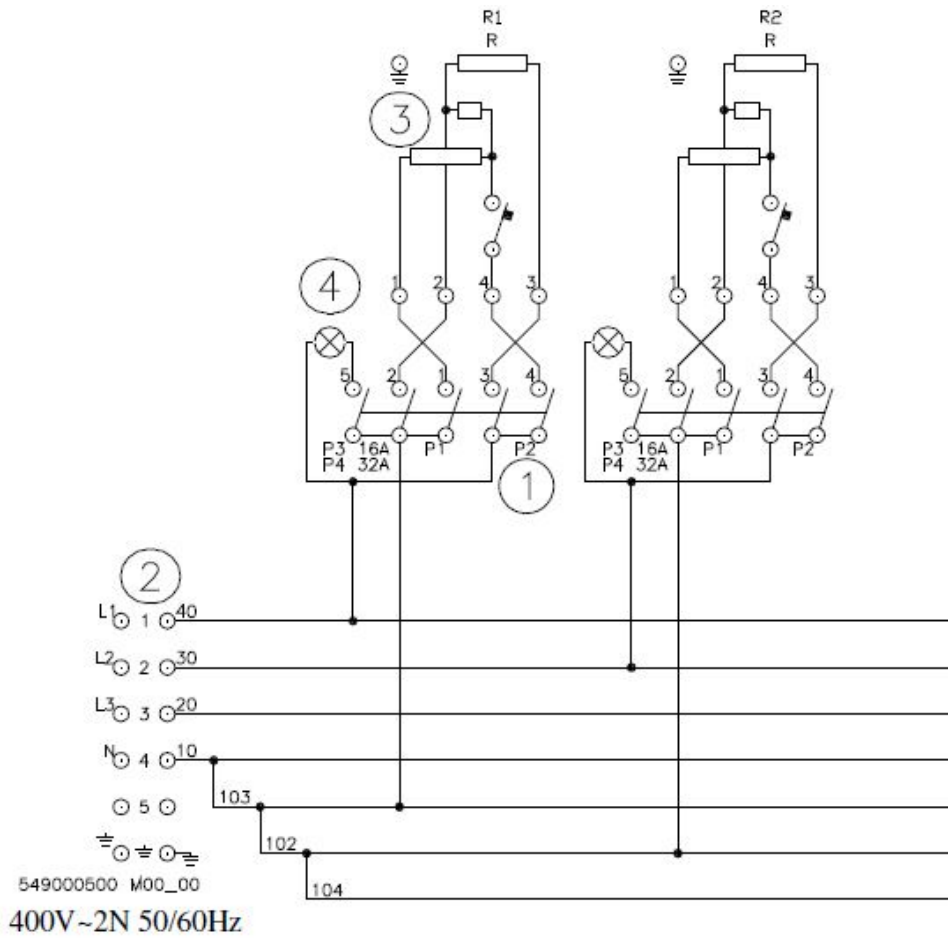

- 1 Power supply terminal board
- 2 Switch
- 3 Electrical plate
- 4 White indicator light

**WIRING DIAGRAM PCQ-118ET, CFQ4-118ET**

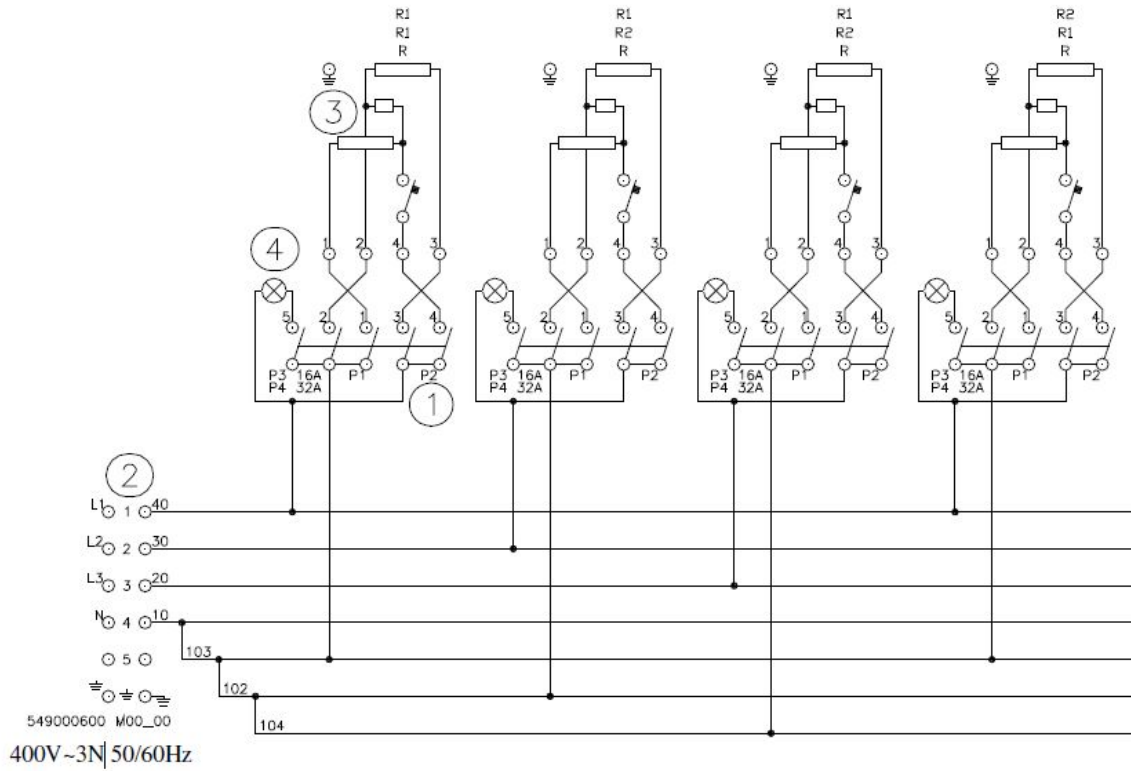

- 1 Power supply terminal board
- 2 Switch
- 3 Electrical plate
- 4 White indicator light

**COMMUTATION**

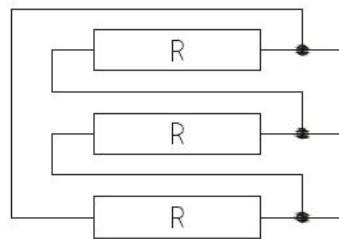
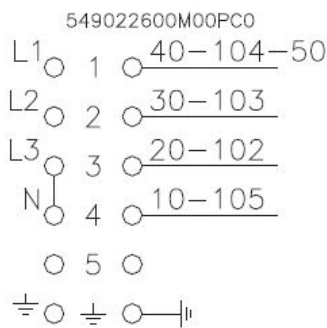

549019400

230V~3 50/60Hz

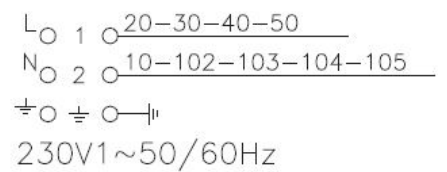

WIRING DIAGRAM OVEN

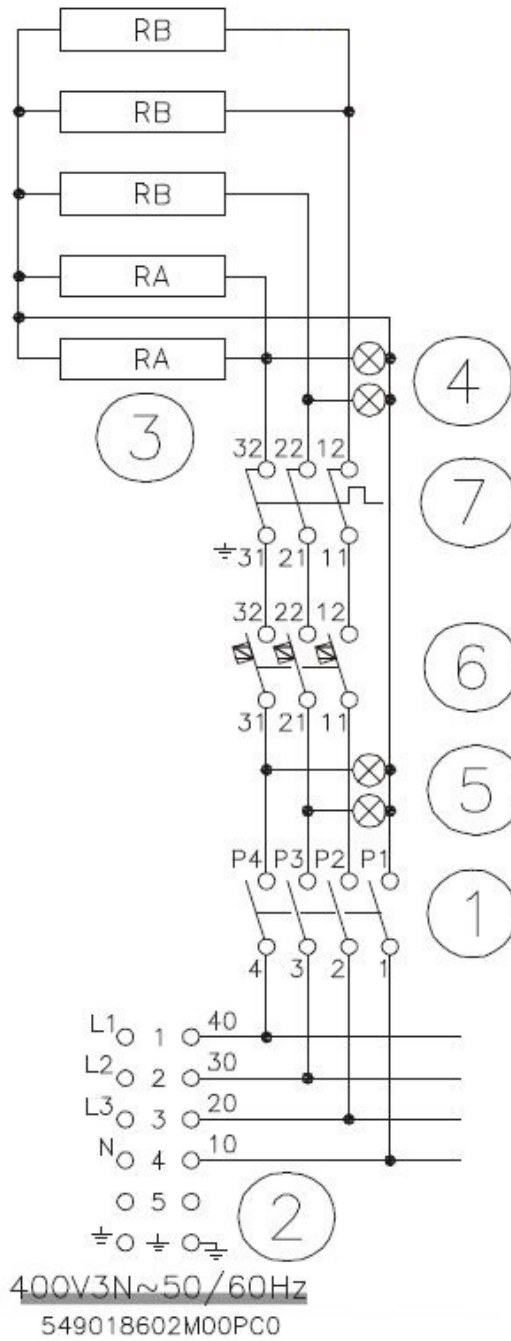

- 1 Switch
- 2 Power supply terminal board
- 3 Heating element
- 4 White indicator light
- 5 Green indicator light
- 6 Thermostat
- 7 Safety thermostat

## 1.2 Example installation of the appliance

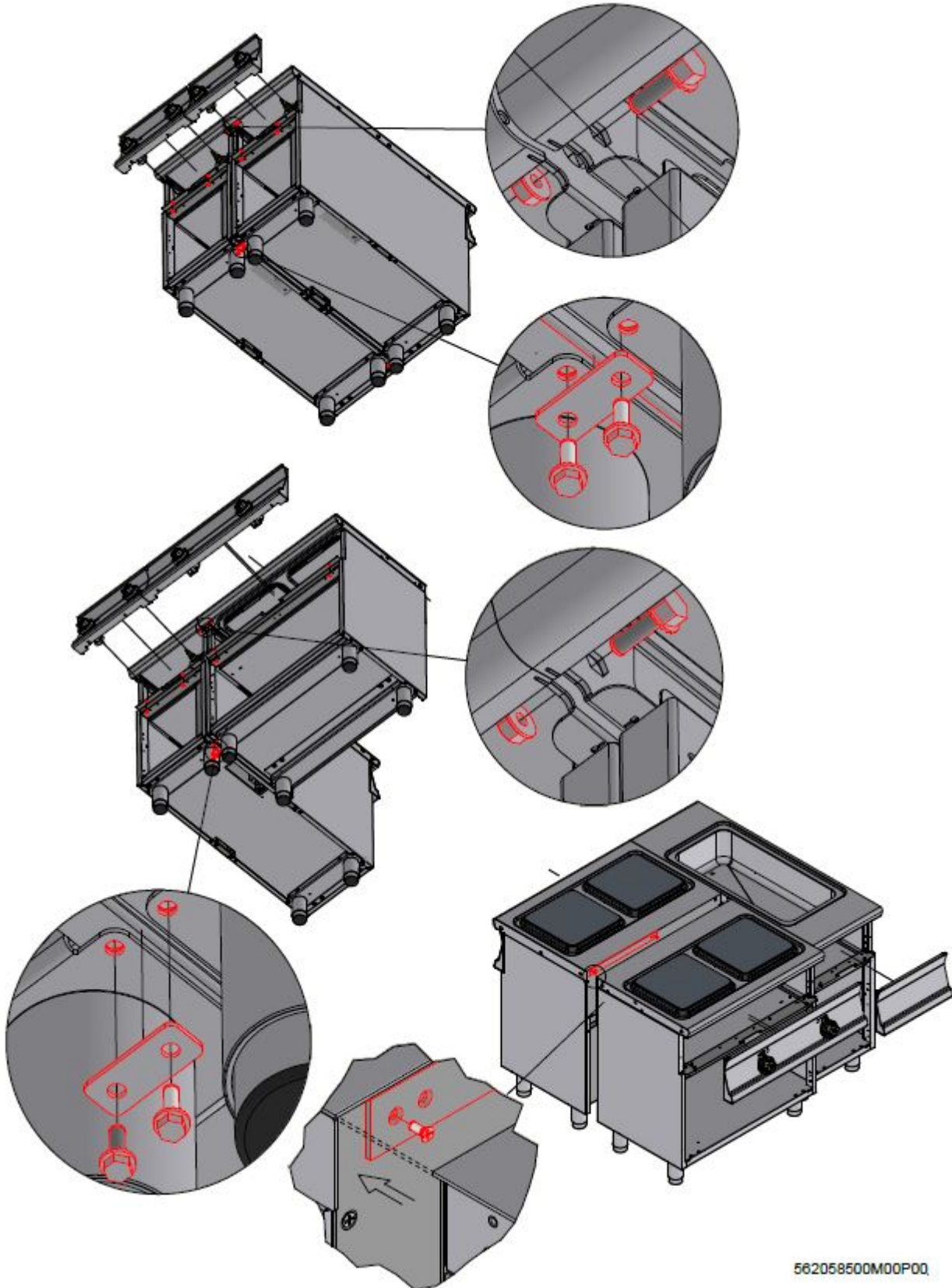

562058500M00P00



## 2 GENERAL INFORMATION

### 2.1 Declaration of compliance

The manufacturer declares that the appliances comply with the requirements of the regulation GAR 2016/426 for the gas part and directive 2014/30/EU, 2014/35/EU for the electrical part. Installation must be performed in compliance with current regulations, especially with regard to ventilation of the premises and the exhaust gas evacuation system.

- Read the warnings in this manual carefully. They provide important information about safe installation, use and maintenance.
- The instruction manual must be kept for the entire duration of the equipment and made available to users for every possible consultation. The manual should be consulted for any information concerning installation, use and maintenance of the appliance.
- After removing the packaging, check the integrity of the equipment.
- All packaging materials (plastic bags, polystyrene, staples, etc.) must be disposed of in compliance with current regulations.
- Before connecting the appliance, make sure that the information on the data plate matches the electricity and gas mains where the appliance is installed. **The manufacturer accepts no liability if the equipment is not connected in accordance with current regulations.**
- Always keep all parts of the equipment clean to avoid the risk of oxidation/rust and/or aggression by chemical agents.
- The equipment must only be used by personnel trained for the purpose.
- **The installation must be implemented by professionally qualified personnel in accordance with the manufacturer's instructions and current reference standards.**
- The electrical safety of this equipment is only ensured when it is correctly connected to an effective ground/earth system as required by current electrical safety standards. The manufacturer cannot be held liable for any damage caused if the system is not connected to ground/earth.
- Before carrying out any cleaning or maintenance tasks on the equipment, unplug it from the electricity mains. In the event of faults or malfunctions, always deactivate the appliance.
- **Repair work of any kind must only be performed by qualified personnel.**
- This appliance must only be used for its expressly intended purpose for cooking or heating food. Any other use is considered improper.
- The appliance is intended for professional use and must be used by trained personnel.
- The installation and possible transformation to another power supply voltage (if envisaged), or transformation for operation with another type of gas, must be implemented exclusively by qualified and authorised professional personnel.
- Before using the appliance, carefully clean all surfaces intended to come into contact with food.
- The manufacturer declines any and all liability for any direct or indirect damage resulting from improper use of the equipment. The manufacturer declines any and all liability for damage caused by incorrect installation, tampering, poor maintenance and unskilled use. Moreover, the manufacturer declines any liability for possible inaccuracies that may be contained in this booklet attributable to errors in transcription or printing and equally reserves the right to make any changes to the product it deems useful and/or necessary without compromising its essential characteristics.
- **The manufacturer cannot be held liable for any damage caused by failure to comply with these basic standards and all other use and maintenance standards contained in this booklet.**

## 2.2 User information, RAEE Directive on waste electrical and electronic equipment

With regard to the regulatory framework of reference of the European Community, we remind the user of the following:

- Used AAE (Electrical and Electronic Equipment) products must be collected separately
- The user can carry out this collection in the RAEE collection systems and return the equipment to the distributor when purchasing a new one
- Plus being RoHS compatible, (in accordance with Directive 2011/65/EU on the restriction of the use of certain hazardous substances in electrical and electronic equipment) the potential effects on the environment and human health may be due to the misuse of the same equipment or parts of it
- The symbol  next to the rating plate indicates the obligation of separate collection
- The penalties provided for in the event of improper disposal of RAEE (Waste Electrical and Electronic Equipment) are those provided for by the national transpositions of European Directives 2012/19/EU

## 2.3 Technical data table

Technical data table PC CF S110E

MODEL	DIMENSIONS	POWER SUPPLY	MAXIMUM ABSORPTION (A)	MAXIMUM POWER (kW)	POWER SUPPLY CABLE silicon type
PCQ-558ET	80x55x90h	400V~2N 50/60 Hz	17,39	8	4 x 2,5 mm <sup>2</sup>
PCQ-118ET	80x110x90h	400V~3N 50/60 Hz	34,78	16	5 x 6 mm <sup>2</sup>
CFQ4-98ET	80x110x90h	400V~3N 50/60 Hz	42,61	23,5	5 x 10 mm <sup>2</sup>

### Transformation

MODEL	DIMENSIONS	POWER SUPPLY	MAXIMUM POWER (kW)	MAXIMUM ABSORPTION (A)	POWER SUPPLY CABLE silicon type
PCQ-558ET	80x55x90h	230V~3 50/60 Hz	8	30,12	4 x 4 mm <sup>2</sup>
PCQ-558ET	80x55x90h	230V~ 50/60 Hz	8	34,78	3 x 6 mm <sup>2</sup>

**DESIGN ASSEMBLY/TRANSFORMATION ELECTRICAL LINKING TERMINAL BLOCK PERNIONS (see technical data table)**

• **POWER SUPPLY CONNECTION**

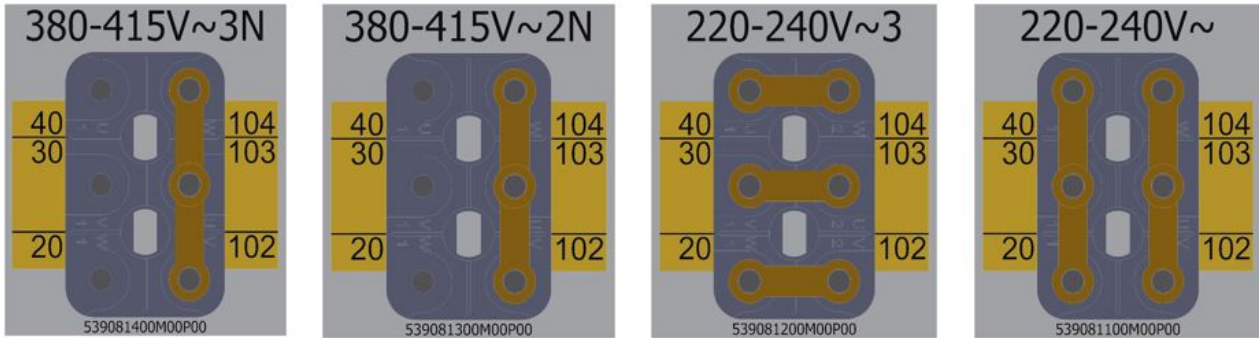

• **HEATING ELEMENT CONNECTION**

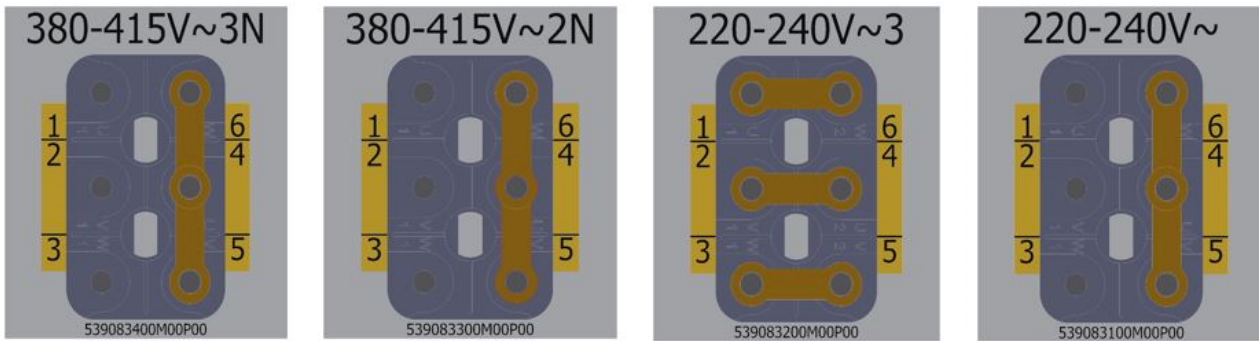

## 3 INSTALLATION

### 3.1 Delivery checks

On delivery, it is important to check the following:

- External conditions of the packaging
- The general status of the equipment
- The conformity of the model with the information in the technical data plate and the instruction manual
- The conformity of the equipment and components to the order form

### 3.2 Removing the packaging

While removing the packaging, take care not to damage the appliance. Remove the protective film from the stainless steel and eliminate any traces of glue. Do not smoke. Perform this operation away from sources of heat and wear protective gloves. Do not disperse packaging material in the environment, keep it out of the reach of children and dispose in compliance with current legislation.

### 3.3 Mechanical installation

Place the appliance on a flat base. Adjust and stabilise the appliance by acting on the support feet. Make sure that the surrounding walls and/or equipment are capable of withstanding the heat emitted by this appliance. Connect the water supply (if necessary).



#### Caution

**Do not install the appliance near equipment/machines used in cold processes. If the appliance has to be installed close to cold process equipment, it is advisable to install non-combustible thermal insulating material and/or neutral elements between them.**

### 3.4 Electrical/gas connections

Before being offered for sale on the market, the appliance was subjected to gas and electrical testing (as required). The appliance is supplied without a power cable. The installation technician must connect the equipment in compliance with current safety regulations on the basis of the power of the appliance.



#### Note

*The ID plate is located in the compartment inside the door for appliances with compartments, or on the left side for appliances with an oven or a top. A second plate with the model and serial number is located inside the dashboard and a third is included with the certificate of conformity. The serial number can also be tracked from the sales document (after 2008). The plate has all the data needed for correct electrical installation. The installation and possible conversion to another power supply voltage (if envisaged) must be implemented exclusively by professionally qualified and authorized personnel. Before using the appliance, carefully clean all surfaces intended to come into contact with food.*

**Warning**

**Installation operations, any conversion to other types of gas and start-up must only be performed by qualified personnel, in accordance with current regulations.**

Gas systems, electrical connections and premises where the appliances are installed must comply with current regulations in the country of installation; in particular, the appliance must be installed in a room with good ventilation, if possible under a suction hood to ensure complete evacuation of the exhaust gases formed during combustion. The air required for combustion is 2 m<sup>3</sup>/h per kW of installed power. The appliance can be installed alone or in series with other appliances in our production range. A minimum distance of 10 cm between appliances must be respected to prevent contact with any walls made of flammable material; furthermore, appropriate measures should also be adopted to ensure the thermal insulation of flammable parts, such as the installation of heat shields; take special care to ensure that appliances are installed in an appropriate and safe manner. The support feet can be adjustable in height and any unevenness can therefore be eliminated.

### ELECTRICAL CONNECTION

**Caution**

**In accordance with international provisions, when connecting the appliance an automatic device must be installed up-line of it so that the device can be fully disconnected from the mains; this device must have a contact aperture of at least 3 mm.**

The connection terminal is located behind the rear wall. Proceed as follows to install the power supply cable:

- Remove the rear panel.
- Pass the new connection cable through the cable gland, connect the leads to the corresponding terminal on the terminal block and fasten them securely.
- Lock the cable with the cable gland and refit the panel. The earth/ground lead must be longer than the others so that if the cable gland breaks it is disconnected after the power cables.

**Note**

*Make sure that the mains voltage complies with the data on the appliance's ID plate and that there is good conductivity to earth/ground. Pay attention when inserting leads to ensure they do not obstruct the normal course of work and routine appliance cleaning operations. Also make sure that the power cable is never pulled taut and is not placed in contact with sources of heat.*

**Note**

***The connection cable must have the following characteristics: it must be silicone type (to withstand temperatures of 180 °C), and must have an appropriate cross-section for the power of the appliance (see technical data table).***

**EQUIPOTENTIAL**

The appliance must be connected to an equipotential system. The connecting screw is located on the rear of the appliance and is marked by the yellow symbol above it.

**Warning**

***The manufacturer is not liable for and does not indemnify damages caused by incorrect inadequate installations that do not comply with these instructions.***

## 4 INSTRUCTIONS FOR USE

### 4.1 General information

This appliance must only be used for its expressly intended purpose for cooking or heating food. Any other use is considered improper. The appliance is also intended for industrial use and **must only be used by personnel trained for use and aware of the risks that the hot element entails.**





#### Warning

*The appliance operates at high temperatures, so the following is necessary:*

- *Pay attention to the areas surrounding the hot surface during routine normal operation (danger of scalding);*
- ***RISK OF BURNS*** *Do not touch hot surfaces floor with your hands or other parts of the body to avoid burns caused by high temperatures;*
- *After switching off the appliance, wait for a sufficient time for it to cool before carrying out any cleaning or maintenance operation.*

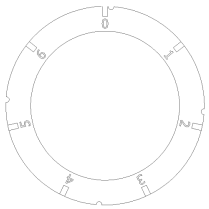
### 4.2 Lighting and adjusting the open rings



On the front panel, a plate is indicated above the knob to which it corresponds, marked by the index 

- Turn on the switch located upstream of the appliance. Turn the control knob that corresponds to the plate from "O" to the desired heating level, between 1 and 6
- The indicator light turns on as soon as the appliance is powered



#### Note

*To start up the plate, we recommend starting all plates and operating them at maximum power in order to eliminate any moisture that might have remained in the insulation of the heating elements.*

*It is recommended to start the plate at the maximum level and, once the temperature is reached, turn the control lever to the desired level. Turn the knob to "O" to switch off the plate.*



#### Warning

**Each plate has a temperature limiter that interrupts the current supply once a temperature of 450°C is reached**



#### Caution

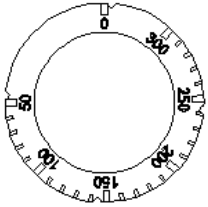

- Never operate the electrical plate without a pot
- The pot must have a smooth bottom with a diameter suitable for the plate (never smaller)

### 4.3 Turning on and adjusting the static oven

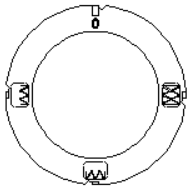

- Turn the control knob to the right and set the desired temperature
- Also turn the knob of the selector, setting one of the three positions



-  Top + bottom heating element
-  Bottom heating element
-  Top heating element

## 5 MAINTENANCE

### 5.1 Routine

When using the appliance over time, it is essential to perform regular maintenance to ensure safe operation. We therefore recommend stipulating a service contract.



#### Caution

**Maintenance must only be performed by specialist personnel in compliance with current regulations and our own instructions.**

Before carrying out any maintenance and/or cleaning operation:

- Disconnect the appliance from the mains power supply and/or close the gas.
- Wait for a sufficient time for the appliance to cool down.
- Do not wash the appliance with direct or high-pressure jets of water, since any infiltration of water into the electrical components could jeopardise correct operation of the appliance and its safety systems.



#### Warning

**For maintenance/replacement of components, order and use only original spare parts.**

Replacing parts must exclusively be performed by authorised and/or qualified personnel. When replacing the electrical components of the machine and the electrical panels, scrupulously follow the technical characteristics for the replacement component indicated on the component itself. The appliance does not require any special maintenance but during the use of the equipment it is advisable to check the following at least once a year (possibly increasing the frequency depending on the degree of use):

- The status of connections especially on the terminal board and the power supply cable, as well as the status of the gas connections;
- The operating condition of the various components (perform a functional test);
- For appliances fitted with rotary resistances, remove the hub, grease it and replace the three o-ring seals to avoid possible leaks.



## 5.2 Spare parts

It is possible to replace parts such as the valve, the piezoelectric or the ignition control unit (depending on the type of appliance) or the gas pipes easily and quickly.

To replace such parts, proceed as follows:

- **THERMOSTAT** ; after removing the front panel, unscrew the two screws that fasten the thermostat to the panel, then, after disconnecting all the electrical connections, replace the damaged parts and install the new ones in succession
- **POWER REGULATOR or SWITCH**: Remove the knob and open the panel, unscrew the two screws that fasten the switch/regulator to the panel, remove all the electrical connections and proceed with replacement
- **HEATING ELEMENT/PLATE** ; remove the panel and remove the wires connecting the heating element/plate. Unscrew the supports that fasten the heating element/plate to the hob. Once removed, make the replacement. In the case of cooker hobs, the plate is removed from the top of the hob, and in the case of glass-ceramic hobs (radiating heating element), it is removed from the bottom



### Caution

#### WHAT TO DO IN THE EVENT OF FAULTS:

Close the gas connection cock and/or switch off the power using the up-line device. Notify customer service.



### Warning

#### MEASURES TO BE TAKEN IF THE APPLIANCE IS NOT TO BE USED FOR A LONG TIME:

Close the gas cock and/or disconnect the power supply. Clean the system as specified above.

## 6 CLEANING

### 6.1 Routine cleaning

**Caution**

**The use of flammable fluids to clean the appliance is forbidden**

To ensure hygiene and the durability of the appliance, perform external cleaning on a regular basis, taking care not to damage the cables and the electrical connections. Before starting cleaning, disconnect the appliance from the power supply. Parts in steel can be washed with warm water and a neutral detergent: Rinse them thoroughly to eliminate all traces of detergent and then dry with a dry cloth. Do not use abrasive and corrosive detergents. Enamelled parts must be washed with soapy water. For appliances that included an oven, cleaning it is made easier by removing the support grid. Thorough, daily cleaning prevents faults and accumulated deposits of fat and/or food. The steels used in the manufacture of professional equipment are tried and tested materials of the highest quality. Thanks to their characteristics, they are ideal materials for use with food substances.

Consequently, when using stainless steel appliances, the following suggestions must be observed:

- Stainless steel surfaces must always be kept clean, also ensuring contact with the air. The lack of oxygen under layers of scale, starch, egg white or other deposits means that surfaces can be affected by corrosion
- Do not use products containing salt or sulphuric acid to remove scale. Suitable products are available commercially but a diluted solution of acetic acid can also be used
- To clean STAINLESS STEEL appliances, it is advisable to use detergents specifically formulated for this material. For "minor cleaning", a mild washing up liquid solution may also be used
- **Do not wash the appliance with jets of water under pressure**
- Avoid using detergents containing abrasive powders or bleaches of any kind
- Lockable stainless steel appliances, during periods of inactivity, must be left uncovered so that air can freely access internal metal surfaces
- Stainless steel must not remain in contact for long periods with concentrated acids or with aromatised concentrates such as salt solutions, mustard, spice mixtures or the like. At certain temperatures and concentrations, these substances can damage the passive layer. Contact surfaces must therefore be immediately rinsed with clean water and then dried
- It is inadvisable to use stainless steel pots exclusively to cook foods in salt water (pasta, rice, potatoes, etc.). From time to time, these pots must also be used to cook foods containing fats or vegetables. This helps to prevent damage caused by corrosion
- After cooking foods in salt water, rinse the tanks with fresh water since salt water residues from cooking form layers of highly concentrated saline solution that can cause spotting corrosion
- To prevent so-called secondary corrosion, prolonged contact of stainless steel with ferritic steels should be avoided
- Any secondary corrosion spots must be eliminated immediately
- Do not use sharp objects that may scratch stainless steel parts and consequently give rise to deterioration