

70

PCT-70E

SuperLOTUS

PIANI COTTURA ELETTRICI E VETROCERAMICA

ELECTRIC AND CERAMIC GLASS BOILING UNIT

ELEKTRO-UND CERAN KOCHPLATTE

PLAN DE CUISSON ELECTRIQUES ET VITROCERAMIQUES

ENCIMERAS DE COCCIÓN ELECTRICOS Y VITROCERÁMICA

Descrizione

Costruzione - Modello realizzato in acciaio inox CrNi 18/10 AISI 304, con piano di spessore 2 mm, satinatura superficiale Scotch-Brite, particolari cromati, profili arrotondati. Piani dotati di alzatina posteriore. Manopole con grado di protezione all'acqua IPX5.

Modello - Piani di cottura elettrici e vetroceramica, per uso professionale. Piastre in ghisa di forma rotonda o quadrata, con bordo di tenuta in acciaio, commutatore a 7 posizioni e limitatore della temperatura. Piani in vetroceramica con piastre di cottura radianti e spie di segnalazione del calore residuo.

Manutenzione - Facilitata grazie a semplice smontaggio cruscotto frontale.

Dotazioni - Piedini regolabili in altezza.



PCT-70E

Description

Construction - Fabricated using CrNi 18/10 AISI 304 grade Stainless Steel Scotch-Brite Satin polish Finish, incorporating 2mm thick worktop, rounded edges, chromed details and rear splash back. Knobs with water-proof grades IPX5.

Model - Professional Electric Boiling Hob. Cast Iron square or round hot plates with steel border seals, seven position switch and temperature limiter. Ceramic glass tops with radiant heat hot plates and warning lights for residual heat.

Maintenance - All serviceable parts are accessible by the easy removal of front control panel.

Fittings - Appliance is supplied with adjustable feet.

Bezeichnung

Aufbau - Modell aus Edelstahl CrNi 18/10 AISI 304 hergestellt, Deckplatte mit einer Stärke von 2 mm, Satinierung der Oberfläche Scotch-Brite, Einzelteile verchromt, abgerundete Profile. Einschübe ausgestattet mit hinterer Aufkantung. Knöpfe mit Wasserschutz IPX5.

Modell - Elektro-und Ceran Kochplatte, für den professionellen Gebrauch. Kochplatten aus Gusseisen mit runder oder quadratischer Form, Einfassung aus Stahl, 7-stufiger Schalter und Temperaturbegrenzung. Platten aus Glaskeramik mit Strahlungskochplatten und Kontrollleuchten zur Anzeige der Restwärme.

Wartung - Erleichtert durch einfachen Ausbau der Frontblende.

Ausstattungen - Höhenverstellbare Füße.

Description

Construction - Modèle réalisé en acier inox CrNi 18/10 AISI 304, avec plan de 2 mm d'épaisseur, satinage superficiel Scotch-Brite, détails chromés, profilés arrondis. Plans équipés de rehausseur postérieur. Manettes avec degré de protection à l'eau IPX5.

Modèle - Plan de cuisson électriques et vitrocéramiques, à usage professionnel. Plaques en fonte de forme arrondie ou carrée, commutateur à 7 positions et limiteur de température. Plans vitrocéramiques avec plaques de cuisson radiantes et voyants de signalisation de chaleur résiduelle.

Entretien - Facilité grâce au démontage simple du panneau frontal.

Équipements - Pieds réglables en hauteur.

Descripción

Construcción - Modelo realizado en acero inox CrNi 18/10 AISI 304, con plano de 2 mm de grosor, satinado superficial Scotch-Brite, detalles cromados y perfiles redondeados. Plano dotado de alzado posterior. Mandos con grado de protección contra el agua IPX5.

Modelo - Encimeras de cocción eléctricos y vitrocerámica para uso profesional. Placas de fundición de forma redonda o cuadrada, con borde de acero, conmutador de 7 posiciones y limitador de la temperatura. Encimeras de vitrocerámica con placas de cocción radiantes y pilotos de señal del calor residual.

Manutención - Facilitada gracias a un desmontaje simple del panel delantero.

Dotaciones - Patas regulables en altura.

21.01.2021



FOOD CATERING EQUIPMENT

70
SuperLOTUS

70

SuperLOTUS

PIANI COTTURA ELETTRICI E VETROCERAMICA
 ELECTRIC AND CERAMIC GLASS BOILING UNIT
 ELEKTRO-UND CERAN KOCHPLATTE
 PLAN DE CUISSON ELECTRIQUES ET VITROCERAMIQUES
 ENCIMERAS DE COCCIÓN ELECTRICOS Y VITROCERÁMICA



PCT-70E

DATI TECNICI / TECHNICAL DATA / TECHNISCHE DATEN
 DONNEES TECHNIQUES / DATOS TÉCNICOS

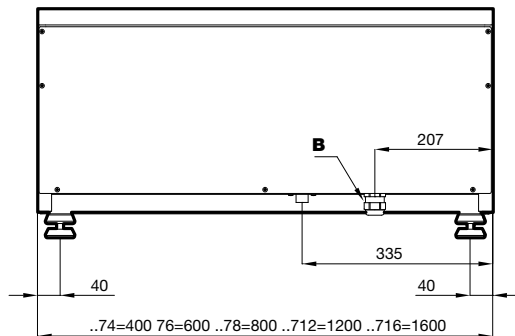
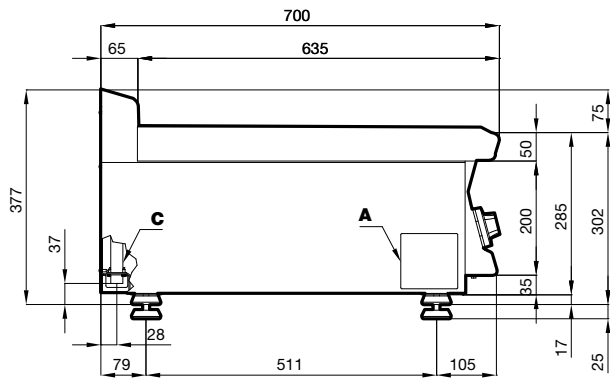

A	Targhetta caratteristiche / Data plate / Typenschild Plaque des caractéristiques / Chapa de características
B	Allacciamento elettrico / Electrical connection / Elektrischer Anschluss / Raccordement électrique / Conexión eléctrica

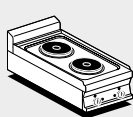

PCT-74ET

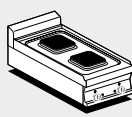

PCQT-74ET

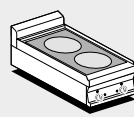

PCCT-74ET

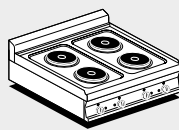

PCT-78ET

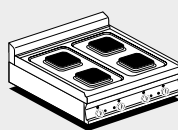

PCQT-78ET

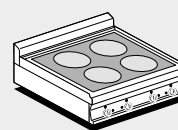

PCCT-78ET

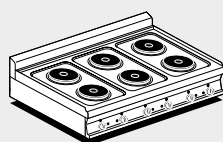

PCT-712ET

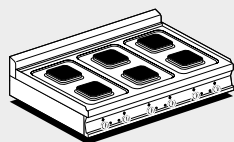

PCQT-712ET

Modelli Models Modele Modelos	Dimensioni Dimensions Abmessungen Dimensions Dimensiones	Piastre e potenza Plates and power Kochplatten und Leistung Plaques et puissance Planchas y potencia	Vetroceramica Ceramic glass Ceran-Kochplatten Vitrocéramique Vitrocerámica	Potenza totale Total power Gesamtleistung Puissance total Potencia total	Voltaggio e frequenza Voltage and frequency Spannung und Frequenz Tension et fréquence Voltaje y frecuencia	Peso/Volume Weight/Volume Gewicht/Volumen Poids/Volume Peso/Volumen
	cm	N° • kW	cm	kW	V- • Hz	kg/m³
PCT-74ET	40x70,5x28h	2 = 2 x 2,6 ●		5,2	400V-2N / 230V-3 / 230V~ • 50/60	26 / 0,180
PCQT-74ET	40x70,5x28h	2 = 2 x 2,6 ●		5,2	400V-2N / 230V-3 / 230V~ • 50/60	30 / 0,180
PCCT-74ET	40x70,5x28h	2 = 2 x 2,5 ○	35x57	5,0	400V-2N / 230V-3 / 230V~ • 50/60	35 / 0,180
PCT-78ET	80x70,5x28h	4 = 4 x 2,6 ●		10,4	400V-3N / 230V-3 • 50/60	63 / 0,350
PCQT-78ET	80x70,5x28h	4 = 4 x 2,6 ●		10,4	400V-3N / 230V-3 • 50/60	66 / 0,350
PCCT-78ET	80x70,5x28h	4 = 4 x 2,5 ○	75x57	10,0	400V-3N / 230V-3 • 50/60	62 / 0,350
PCT-712ET	120x70,5x28h	6 = 6 x 2,6 ●		15,6	400V-3N / 230V-3 • 50/60	82 / 0,510
PCQT-712ET	120x70,5x28h	6 = 6 x 2,6 ●		15,6	400V-3N / 230V-3 • 50/60	97 / 0,510

BUY LOTUS
BUY ITALY

La ditta si riserva di apportare modifiche senza preavviso
 The manufacturer reserves the right to modify the technical data and models without
 previous notice - Technische Änderungen vorbehalten - La Société se réserve le droit
 d'apporter tout modification sans préavis - La Empresa se reserva el derecho de
 introducir, sin preaviso, modificaciones en cualquier momento



ITALIAN CULINARY ART

LOTUS SpA - Via Calmaor, 46
 31020 Zoppé di S. Vendemiano (TV) - ITALY
 Tel. +39 0438 778020 / 778468
 Fax +39 0438 778277
 www.lotuscookers.it - lotus@lotuscookers.it