

65

ACC-65 (1)

magleprof

ACCESSORI
ACCESSORIES
ZUBEHÖR
ACCESSOIRES
ACCESORIOS

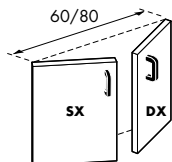

Porta 300/400
Door 300/400
Tür 300/400
Porte 300/400
Puerta 300/400

Modelli Models Modele Modelos	Porta destra Right door Rechte Tür Porte droite Puerta derecha	Porta sinistra Left door Linke Tür Porte gauche Puerta izquierda	Dimensioni Dimensions Abmessungen Dimensions Dimensiones	Peso/Volume Weight/Volume Gewicht/Volumen Poids/Volume Peso/Volumen
			cm	kg/m ³
PM-3DX	●		29,5x2,5x45h	2,5 / 0,010
PM-3SX		●	29,5x2,5x45h	2,5 / 0,010
PM-4DX	●		39,5x2,5x45h	3,5 / 0,010
PM-4SX		●	39,5x2,5x45h	3,5 / 0,010

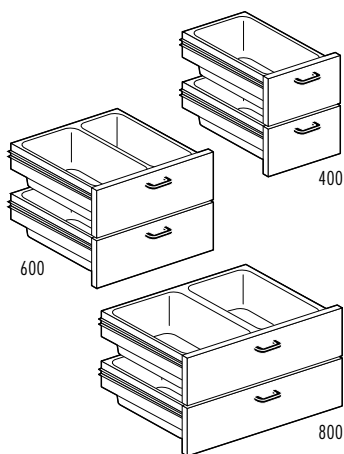

Modelli Models Modele Modelos	Cassetto inox Stainless steel drawer Schublade aus Nirosta Tiroir en acier inox Cajón en acero inox.	Bacinelle inox Stainless steel containers Behältern aus Nirosta Bacs en acier inox Contened. en acero inox.	Bacinelle in plastica Plastic containers Kunststoffbehältern Bacs en plastique Contened. en acero inox.	Guide telescopiche Telescopic guides Telescopieinführungen Guides télescopiques Guías telescópicas	Dimensioni Dimensions Abmessungen Dimensions Dimensiones	Peso/Volume Weight/Vol. Gewicht/Volumen Poids/Volume Peso/Volumen
	N°	N° * cm	N° * GN * cm		cm	kg/m ³
C-4	2		2 * GN 1/1 - 15h	●	39,5x56x45h	18 / 0,110
C-6	2	2 * 17x46,5x15h	2 * GN 1/1 - 15h	●	59,5x56x45h	24 / 0,170
C-8	2		4 * GN 1/1 - 15h	●	79,5x56x45h	26 / 0,220

Cassettiere 400 / 600 / 800
Drawer set 400 / 600 / 800
Schubladen 400 / 600 / 800
Tiroirs pour meuble de 400 / 600 / 800
Cajoneras 400 / 600 / 800

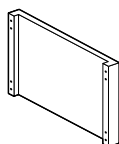

Divisorio (per applicare cassetiera C-4 su mobile M-8)
Spacer (for installation of C-4 on stand M-8)
Trennwand (um ein C-4 an einem Unterschrank M-8 einzubauen)
Separation (pour l'installation de C-4 sur placard M-8)
Divisorio (necesario para aplicar cajoneras C-4 en mueble M-8)

Modelli Models Modele Modelos	Dimensioni Dimensions Abmessungen Dimensions Dimensiones	Peso/Volume Weight/Volume Gewicht/Volumen Poids/Volume Peso/Volumen
	cm	kg/m ³
D-8	5x53,5x38,5h	2 / 0,015

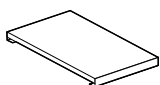

Ripiano 300 / 400 / 600
Shelf 300 / 400 / 600
Zwischenboden 300 / 400 / 600
Etagère 300 / 400 / 600
Estante 300 / 400 / 600

Modelli Models Modele Modelos	Dimensioni Dimensions Abmessungen Dimensions Dimensiones	Ripiano Shelf Etagère Etagère Estante	Peso/Volume Weight/Volume Gewicht/Volumen Poids/Volume Peso/Volumen
	cm		kg/m ³
R-4	35x53x2h	400	1,5 / 0,005
R-6	55x53x2h	600	2 / 0,008
R-8	75x53x2h	800	2,5 / 0,010

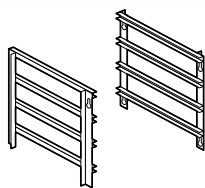

Portateghe vano 400 / 600
Frame for plates 400 / 600
Auflangeschienen für Bleche 400 / 600
Kit porte-plaques 400 / 600
Portacazuelas 400 / 600

Modelli Models Modele Modelos	Dimensioni Dimensions Abmessungen Dimensions Dimensiones	Ripiani Shelves Etagen Etagères Estantes	Interasse Wheel-base Abstand Entraxe Distancia	Peso/Volume Weight/Volume Gewicht/Vol. Poids/Vol. Peso/Vol.
	cm	N°	cm	kg/m ³
PT		4	9	2 / 0,015

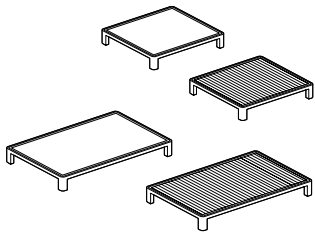

Piastra (per griglie in ghisa)
 Plate (for cast iron grid)
 Platte (für Gusseisen Rost)
 Plaque (pour la grille en fonte)
 Plancha (para rejilla de hierro colado)

Modelli / Models / Modelle / Modelos	1 fuoco / 1 burner / 1 Kochstelle / 1 feu / 1 quemadore	2 fuochi / 2 burners / 2 Kochstellen / 2 feux / 2 quemadores	Liscia / Smooth / Glatt / Lisse / Lisa	Rigata / Grooved / Gerillt / Nervurée / Estriada	Dimensioni / Dimensions / Abmessungen / Dimensiones	Peso / Volume / Weight / Vol. / Gewicht / Vol. / Poids / Volume / Peso / Volumen
					cm	kg/m ³
PLF	●		●		35x27	9 / 0,005
PLF/2		●	●		35x57	18 / 0,010
PRF	●			●	35x27	9 / 0,005
PRF/2		●		●	35x57	18 / 0,010



Griglia di riduzione
 Reduction
 Reduzierstern
 Grille de réduction
 Rejilla de reducción

Modelli / Models / Modelle / Modelos	Dimensioni / Dim. / Abmess. / Dimens. / Dimensiones	Peso / Volume - Weight / Volume / Gewicht / Volum. - Poids / Volume / Peso / Volumen
	cm	kg/m ³
533009200	25x25	0,2 / 0,001

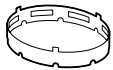

Anello per Wok - Solo per griglie in ghisa
 Wok ring - Only for cast iron grills
 Wok Aufsatzring - Nur für Roste aus Gusseisen
 Anneau Wok - Seulement pour grilles en fonte
 Anillo Wok - Solo para parrillas de hierro colado

Modelli / Models / Modelle / Modelos	Dimensioni / Dimens. / Abmessung. / Dimens. / Dimensiones	Peso / Volume - Weight / Volume / Gewicht / Volum. - Poids / Volume / Peso / Vol.
	cm	kg/m ³
544439900	Ø22,5x3,5h	2 / 0,006

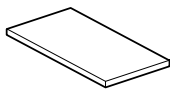

Tagliere plastica
 Plastic chopping-board
 Schneidebrett
 Plan de decoup
 Picador de plástico

Modelli / Models / Modelle / Modelos	Dimensioni / Dimens. / Abmess. / Dimens. / Dimensiones	Peso / Volume - Weight / Volume / Gewicht / Vol. - Poids / Vol. - Peso / Vol.
		kg/m ³
TG-4	39x58x2,5h	6 / 0,015
TG-6	59x58x2,5h	8,5 / 0,020
TG-8	79x58x2,5h	11 / 0,025
TG-10	99x58x2,5h	14 / 0,030

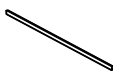

Coprigiunto
 Joint cover / Klemmsteg
 Couvre-joint / Cubre junta

Modelli / Models / Modelle / Modelos	Dim. / Dim. / Abmessungen / Dimens. / Dimensiones	Peso / Volume - Weight / Volume / Gewicht / Vol. - Poids / Vol. - Peso / Vol.
	cm	kg/m ³
CG-65	0,7x58x1,2h	0,1 / 0,0001

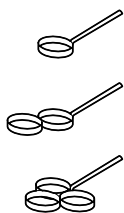

Forma per uova
 Egg poachers
 Eierformer
 Forme a oeuf
 Mode para huevos

Modelli / Models / Modelle / Modelos	Uova / Eggs / Eier / Oeuf / Huevos		Peso / Volume - Weight / Volume / Gewicht / Vol. - Poids / Vol. - Peso / Vol.
	N.	Ø cm	kg/m ³
FU-1X7	1	7	1 /
FU-1X9	1	9	1 /
FU-2X7	2	7	1,5 /
FU-2X9	2	9	1,5 /
FU-3X7	3	7	2 /
FU-3X9	3	9	2 /