

LA-94
562019801 M00_00

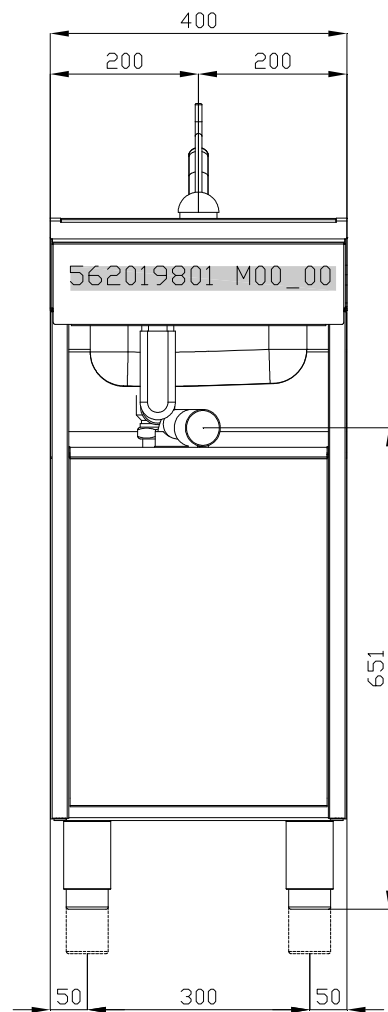

LAT-94
562019901 M00_00

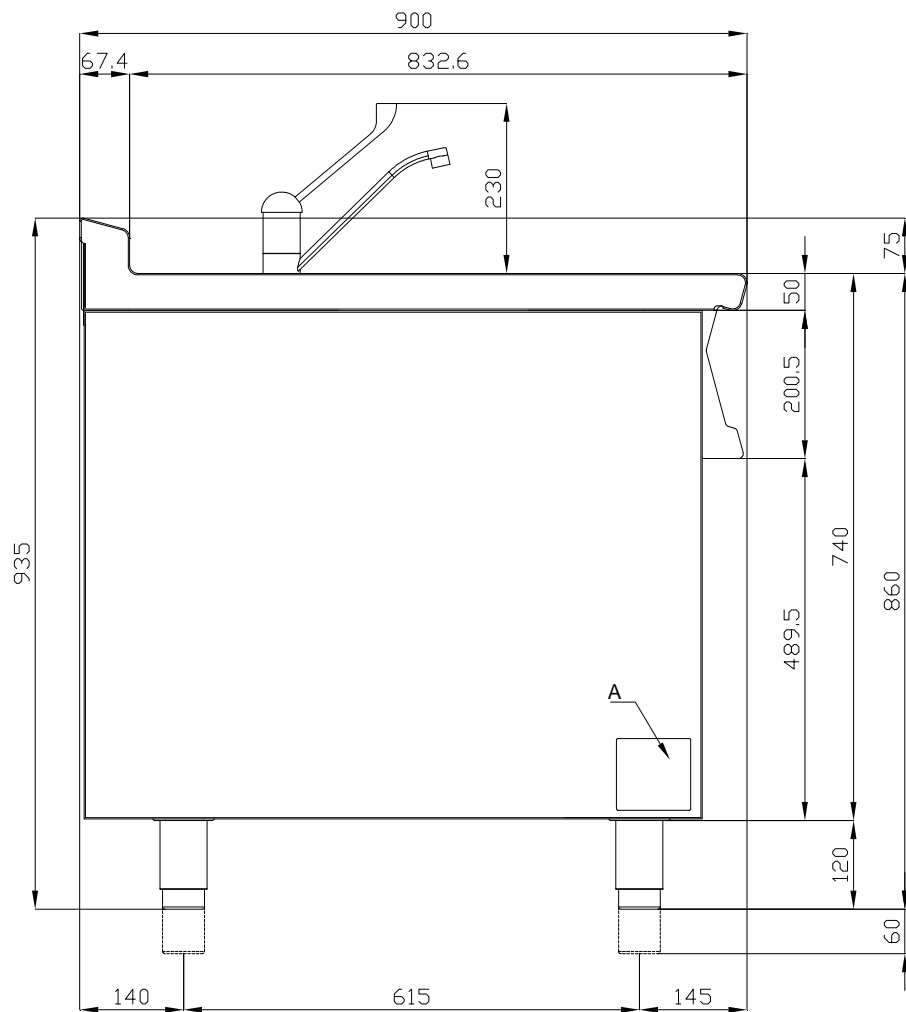
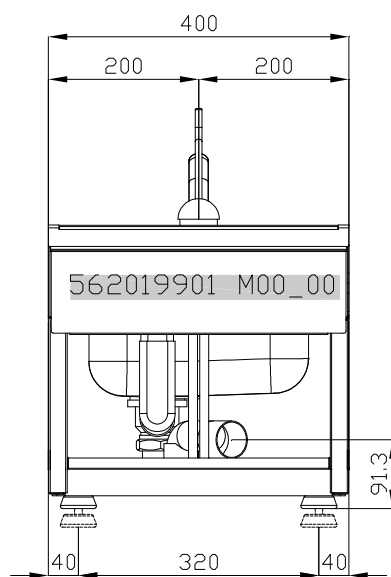
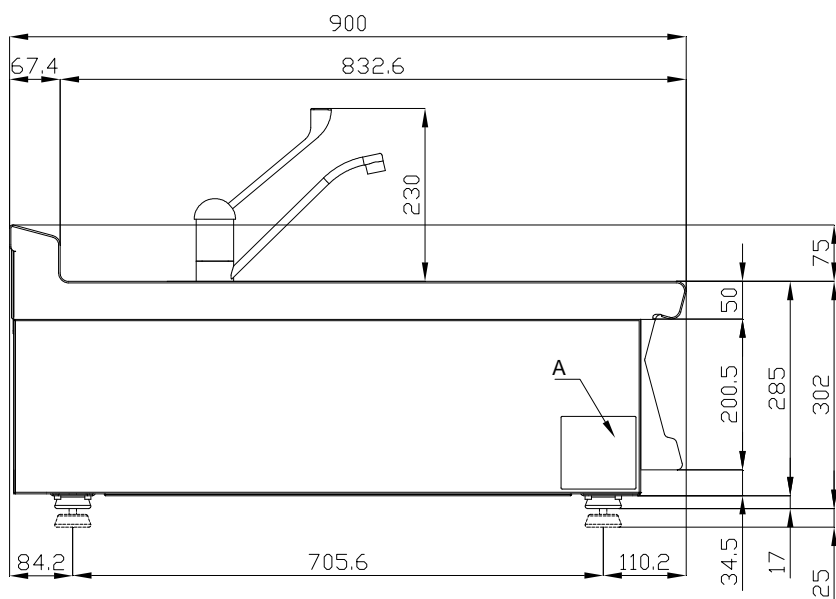

**MOBILI 900, ANBAUMÖMEL 900, MEUBLES 900, MODULAR ELEMENTS 900,
MEUBLES 900**
562032500M00C00

M-...

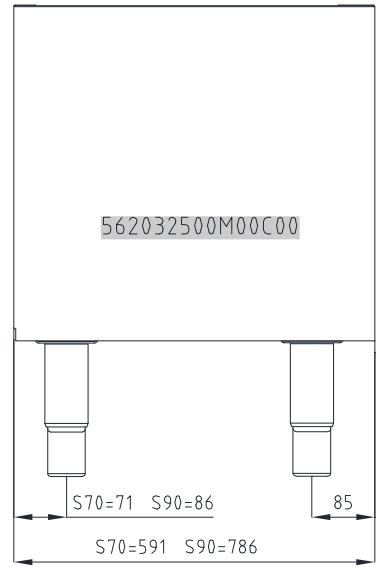
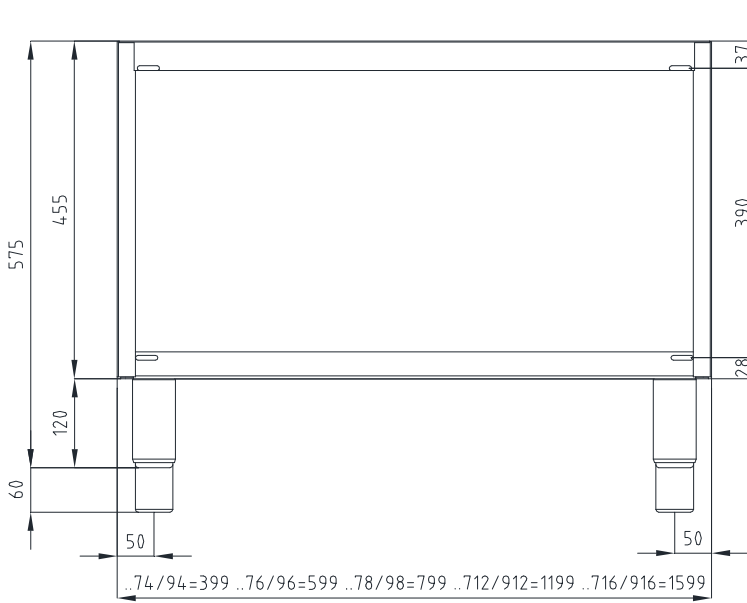

MPI-...

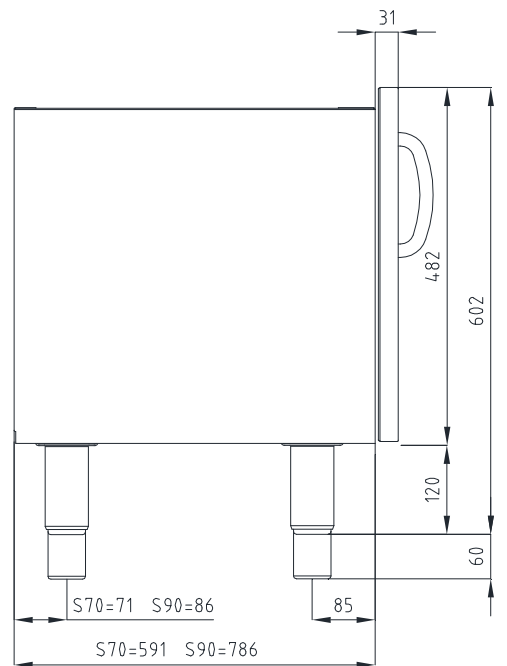
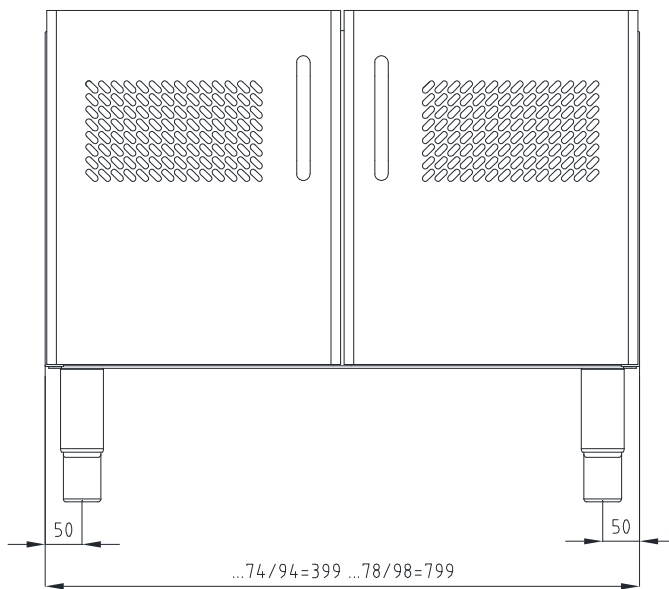

**PIANI LAVORO, ARBEITSPLATTE, PLAN DE TRAVAIL, WORKTOP
SOBRE DE TRABAJO**

562040400 M00_00

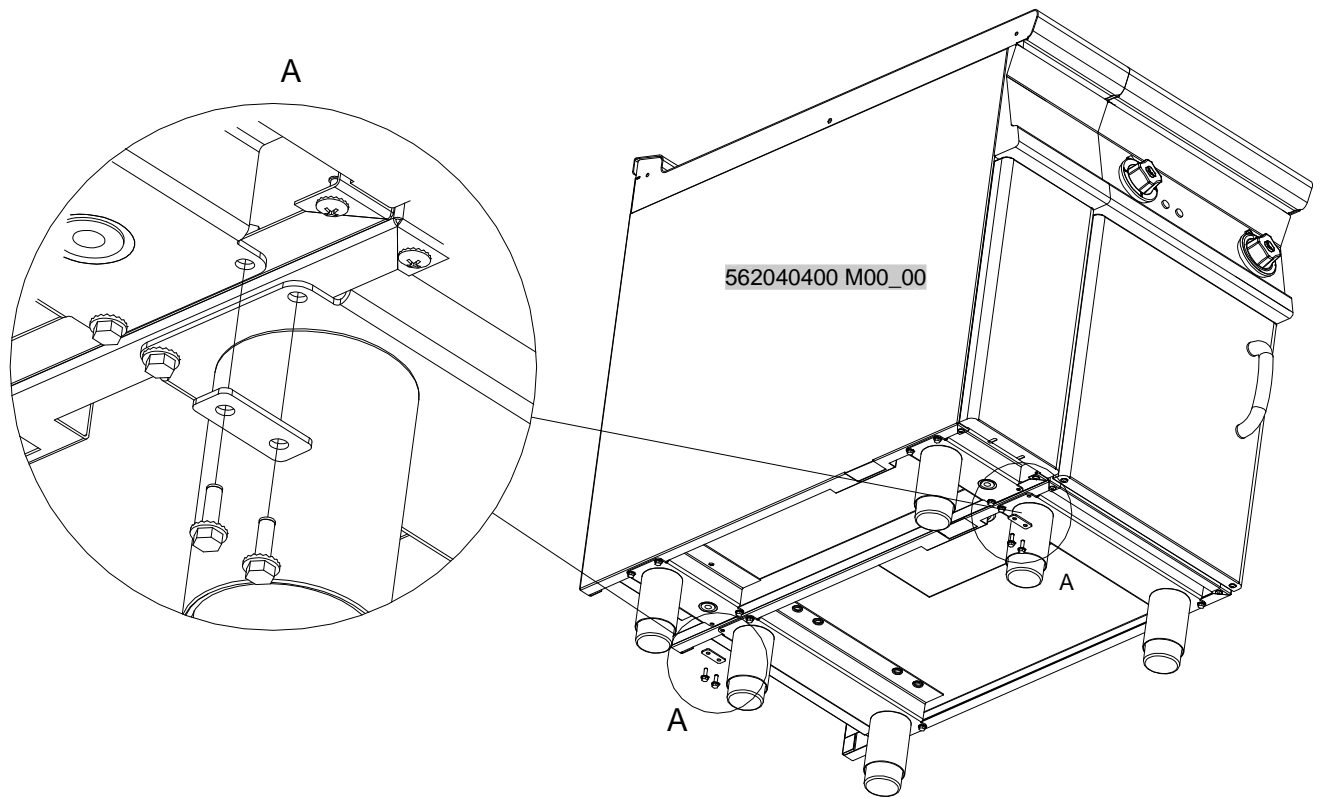

Montare due staffe per apparecchio
Fit zwei Klammern pro Einheit
Insérez deux crochets par unité
Fit two brackets per unit
Fit dos soportes por unidad

ESEMPIO DI FISSAGGIO PER APPARECCHI
BEISPIEL DER FESTSETZUNG FUER GERAETE
EXEMPLE DE MONTAGE POUR EQUIPEMENTS
EXAMPLE OF FIXING FOR EQUIPMENT
EJEMPLO FIJACIÓN DE APARATO

562026000 M00_00

